

CE EMC Test Report (EN 50155 & EN 50121-3-2)

Report No.: CEBDBO-WTW-P21030355-1

Test Model: ECX-2200

Series Model: ECX-2200 Series, ECX-2XXXXXXXXXXXXXXXXXXXXXXXXXXXXXXXXXXXX
("X" can be 0-9, A-Z or blank for marketing purposes)

Received Date: Mar. 10, 2021

Test Date: Mar. 15 to Apr. 13, 2021

Issued Date: Apr. 19, 2021

Applicant: Vecow Co., Ltd.

Address: 3F., No.10, Jiankang Rd., Zhonghe Dist., New Taipei City 23586, Taiwan

Issued By: Bureau Veritas Consumer Products Services (H.K.) Ltd., Taoyuan Branch
Lin Kou Laboratories

Lab Address: No. 47-2, 14th Ling, Chia Pau Vil., Lin Kou Dist., New Taipei City, Taiwan



This report is for your exclusive use. Any copying or replication of this report to or for any other person or entity, or use of our name or trademark, is permitted only with our prior written permission. This report sets forth our findings solely with respect to the test samples identified herein. The results set forth in this report are not indicative or representative of the quality or characteristics of the lot from which a test sample was taken or any similar or identical product unless specifically and expressly noted. Our report includes all of the tests requested by you and the results thereof based upon the information that you provided to us. You have 60 days from date of issuance of this report to notify us of any material error or omission caused by our negligence, provided, however, that such notice shall be in writing and shall specifically address the issue you wish to raise. A failure to raise such issue within the prescribed time shall constitute your unqualified acceptance of the completeness of this report, the tests conducted and the correctness of the report contents. Unless specifically mentioned, the uncertainty of measurement has been explicitly taken into account to declare the compliance or non-compliance to the specification.

Table of Contents

| | |
|---|-----------|
| Release Control Record | 4 |
| 1 Certificate of Conformity | 5 |
| 2 Summary of Test Results | 6 |
| 2.1 Performance Criteria | 9 |
| 2.2 Measurement Uncertainty | 9 |
| 2.3 Modification Record..... | 9 |
| 3 General Information | 10 |
| 3.1 Description of EUT | 10 |
| 3.2 Features of EUT | 10 |
| 3.3 Operating Modes of EUT and Determination of Worst Case Operating Mode | 11 |
| 3.4 Test Program Used and Operation Descriptions..... | 12 |
| 3.5 Primary Clock Frequencies of Internal Source | 12 |
| 4 Configuration and Connections with EUT | 13 |
| 4.1 Connection Diagram of EUT and Peripheral Devices..... | 13 |
| 4.2 Configuration of Peripheral Devices and Cable Connections | 15 |
| 5 Conducted Disturbance at Auxiliary a.c. or d.c. Power Ports | 17 |
| 5.1 Limits | 17 |
| 5.2 Test Instruments | 17 |
| 5.3 Test Arrangement | 18 |
| 5.4 Test Results | 19 |
| 6 Radiated Disturbance up to 1 GHz | 21 |
| 6.1 Limits | 21 |
| 6.2 Test Instruments | 21 |
| 6.3 Test Arrangement | 22 |
| 6.4 Test Results | 23 |
| 7 Radiated Disturbance above 1 GHz | 25 |
| 7.1 Limits | 25 |
| 7.2 Test Instruments | 25 |
| 7.3 Test Arrangement | 26 |
| 7.4 Test Results | 27 |
| 8 Harmonics Current Measurement | 29 |
| 8.1 Limits | 29 |
| 8.2 Classification of Equipment..... | 29 |
| 8.3 Test Instruments | 29 |
| 8.4 Test Arrangement | 30 |
| 8.5 Test Results | 30 |
| 9 Voltage Fluctuations and Flicker Measurement | 31 |
| 9.1 Limits | 31 |
| 9.2 Test Instruments | 31 |
| 9.3 Test Arrangement | 31 |
| 9.4 Test Results | 32 |
| 10 Electrostatic Discharge Immunity Test (ESD) | 33 |
| 10.1 Test Specification..... | 33 |
| 10.2 Test Instruments | 33 |
| 10.3 Test Arrangement | 33 |
| 10.4 Test Results | 35 |

| | | |
|---|---|-----------|
| 11 | Radio-frequency Electromagnetic Field Immunity Test (RS) | 40 |
| 11.1 | Test Specification..... | 40 |
| 11.2 | Test Instruments | 40 |
| 11.3 | Test Arrangement | 41 |
| 11.4 | Test Results | 42 |
| 12 | Electrical Fast Transient/Burst Immunity Test (EFT) | 43 |
| 12.1 | Test Specification..... | 43 |
| 12.2 | Test Instruments | 43 |
| 12.3 | Test Arrangement | 44 |
| 12.4 | Test Results | 45 |
| 13 | Surge Immunity Test | 46 |
| 13.1 | Test Specification..... | 46 |
| 13.2 | Test Instruments | 46 |
| 13.3 | Test Arrangement | 47 |
| 13.4 | Test Results | 47 |
| 14 | Immunity to Conducted Disturbances Induced by RF Fields (CS) | 48 |
| 14.1 | Test Specification..... | 48 |
| 14.2 | Test Instruments | 49 |
| 14.3 | Test Arrangement | 50 |
| 14.4 | Test Results | 51 |
| 15 | Pictures of Test Arrangements | 52 |
| 15.1 | Conducted Disturbance at Auxiliary a.c. or d.c. power ports | 52 |
| 15.2 | Radiated Disturbance up to 1 GHz | 53 |
| 15.3 | Radiated Disturbance above 1 GHz..... | 54 |
| 15.4 | Harmonics Current, Voltage Fluctuations and Flicker Measurement..... | 55 |
| 15.5 | Electrostatic Discharge Immunity Test (ESD) | 55 |
| 15.6 | Radio-frequency Electromagnetic Field Immunity Test (RS) | 56 |
| 15.7 | Fast Transients (EFT)..... | 57 |
| 15.8 | Surge | 59 |
| 15.9 | Radio-frequency common mode (CS)..... | 60 |
| Appendix – Information of the Testing Laboratories | | 62 |

Release Control Record

| Issue No. | Description | Date Issued |
|------------------------|-------------------|---------------|
| CEBDBO-WTW-P21030355-1 | Original release. | Apr. 19, 2021 |

1 Certificate of Conformity

Product: Expandable Embedded Box PC
Brand: Vecow
Test Model: ECX-2200
Series Model: ECX-2200 Series, ECX-2XXXXXXXXXXXXXXXXXXXXXXXXXXXXX
(“X” can be 0-9, A-Z or blank for marketing purposes)
Sample Status: Engineering sample
Applicant: Vecow Co., Ltd.
Test Date: Mar. 15 to Apr. 13, 2021
Standards: **EN 50155:2017, Clause 13.4.8**
EN 61000-3-2:2014, Class D
EN 61000-3-3:2013
EN 50121-1:2017
EN 50121-3-2:2016
EN 61000-4-2:2009
EN 61000-4-3:2006 +A1:2008 +A2:2010
EN 61000-4-4:2012
EN 61000-4-5:2014 +A1:2017
EN 61000-4-6:2014 +AC:2015

The above equipment has been tested by **Bureau Veritas Consumer Products Services (H.K.) Ltd., Taoyuan Branch**, and found compliance with the requirement of the above standards. The test record, data evaluation & Equipment Under Test (EUT) configurations represented herein are true and accurate accounts of the measurements of the sample’s EMC characteristics under the conditions specified in this report.

Prepared by :  , **Date:** Apr. 19, 2021
Vivian Chen / Specialist

Approved by :  , **Date:** Apr. 19, 2021
Jim Hsiang / Associate Technical Manager

2 Summary of Test Results

| EN 50121-3-2:2016, Emission requirements, EN 50155:2017, Clause 13.4.8 | | | |
|---|---|---|---------|
| Port | Test Item / specifications | Result/Remarks | Verdict |
| Auxiliary a.c. or d.c. power ports - Auxiliary supply sinusoidal a.c. or d.c. | Conducted disturbance 150 kHz- 500 kHz: 99 dB μ V quasi-peak 500 kHz- 30 MHz: 93 dB μ V quasi-peak | Minimum passing margin is -52.61 dB at 7.08456 MHz | Pass |
| Auxiliary a.c. or d.c. power ports – AC power outlet port for public use | Conducted disturbance 50 Hz- 2 kHz: THD <8% (THD: total harmonic distortion) | Test not applicable because the port does not exist. | N/A |
| Battery referenced ports - Battery power supply | Conducted disturbance 150 kHz- 500 kHz: 99 dB μ V quasi-peak 500 kHz- 30 MHz: 93 dB μ V quasi-peak | Test not applicable because the port does not exist. | N/A |
| Enclosure | Radiated disturbance 30 MHz- 230 MHz: 40 dB μ V/m quasi-peak 230 MHz -1 GHz: 47 dB μ V/m quasi-peak | Minimum passing margin is -5.53 dB at 216.00 MHz | Pass |
| Enclosure | Radiated disturbance 1 GHz- 3 GHz: 76 dB μ V/m peak 56 dB μ V/m average 3 GHz - 6 GHz: 80 dB μ V/m peak 60 dB μ V/m average | Minimum passing margin is -9.46 dB at 2309.85 MHz | Pass |

| Emission requirements | | | |
|-----------------------|----------------------------------|---|---------|
| Standard | Test Item / specifications | Result/Remarks | Verdict |
| EN 61000-3-2:2014 | Harmonic current emissions | Class D | Pass |
| EN 61000-3-3:2013 | Voltage fluctuations and flicker | $P_{st} \leq 1.0$ $d_{max} \leq 4\%$ $P_{lt} \leq 0.65$ $d_c \leq 3.3\%$ $T_{max} \leq 500ms$ | Pass |

EN 50121-3-2:2016, Immunity requirements,
 EN 50155:2017, Clause 13.4.8

| Table Clause | Basic standard | Port | Test Item / specifications | Result/Remarks | Verdict |
|--------------|--|---|--|-------------------------|---------|
| 3.1 | EN 61000-4-6:2014 +AC:2015 | Battery referenced ports (except at the output of energy sources), Auxiliary a.c. power input ports (rated voltage ≤ 400 Vrms) | Radio-frequency common mode (CS) 80% AM (1kHz) 0.15-80 MHz, 10V Performance Criterion A | Performance Criterion A | Pass |
| 3.2 | EN 61000-4-4:2012 | Battery referenced ports (except at the output of energy sources), Auxiliary a.c. power input ports (rated voltage ≤ 400 Vrms) | Fast Transients (EFT) 5/50 (t_r/t_w) ns, 5kHz ± 2 kV Performance Criterion A | Performance Criterion A | Pass |
| 3.3 | EN 61000-4-5:2014 +A1:2017 | Battery referenced ports (except at the output of energy sources), Auxiliary a.c. power input ports (rated voltage ≤ 400 Vrms) | Surges 1.2/50 (8/20) (T_f/T_d) μ s Line to ground: ± 2 kV 42 Ω , 0.5 μ F Line to line: ± 1 kV 42 Ω , 0.5 μ F Performance Criterion B | Performance Criterion A | Pass |
| 4.1 | EN 61000-4-6:2014 +AC:2015 | Signal & communication, process measurement & control ports | Radio-frequency common mode (CS) 80% AM (1kHz) 0.15-80 MHz, 10V Performance Criterion A | Performance Criterion A | Pass |
| 4.2 | EN 61000-4-4:2012 | Signal & communication, process measurement & control ports | Fast Transients (EFT) 5/50 (t_r/t_w) ns, 5kHz ± 2 kV, Capacitive clamp Performance Criterion A | Performance Criterion A | Pass |
| 5.1 | EN 61000-4-3:2006 +A1:2008 +A2:2010 | Enclosure ports | Radio-frequency electromagnetic field amplitude modulated (RS) ¹ , 80% AM (1kHz) 80-800 MHz, 20V/m Performance Criterion A | Performance Criterion A | Pass |
| 5.2 | EN 61000-4-3:2006 +A1:2008 +A2:2010 | Enclosure ports | Radio-frequency electromagnetic field from digital mobile telephones (RS) ² , 80% AM (1kHz) 800-1000 MHz, 20V/m 1400-2000 MHz, 10V/m 2000-2700 MHz, 5V/m 5100-6000 MHz, 3V/m Performance Criterion A | Performance Criterion A | Pass |

EN 50121-3-2:2016, Immunity requirements,
EN 50155:2017, Clause 13.4.8

| Table Clause | Basic standard | Port | Test Item / specifications | Result/Remarks | Verdict |
|--------------|-------------------|-----------------|---|-------------------------|---------|
| 5.3 | EN 61000-4-2:2009 | Enclosure ports | Electrostatic Discharges (ESD) ±6kV Contact discharge ±8kV Air discharge Performance Criterion B | Performance Criterion B | Pass |

Note 1: This limit applies to equipment mounted in the passenger compartments, drivers cab or external to the rolling stock (roof, underframe). For equipment mounted in all other areas a severity level of 10 V/m may be used.

Note 2: For large apparatus (e.g. traction drives, auxiliary converters) it is often not practical to perform the immunity test to radiated electromagnetic fields on the complete unit. In such cases the manufacturer should test susceptible sub-systems (e.g. control electronics). The test report should justify the selection or not of sub-systems and any assumptions made (e.g. reduction of field due to case shielding).

Note:

1. There is no deviation to the applied test methods and requirements covered by the scope of this report.
2. The above EN basic standards are applied with latest version if customer has no special requirement.
3. Determining compliance based on the results of the compliance measurement, not taking into account measurement instrumentation uncertainty.
4. N/A: Not Applicable

2.1 Performance Criteria

General Performance Criteria

The general performance criteria apply for those ports for which no specific performance criteria are defined (e.g. auxiliary ports) in the report.

Performance criterion A: The apparatus shall continue to operate as intended during and after the test. No degradation of performance or loss of function is allowed below a performance level specified by the manufacturer, when the apparatus is used as intended. The performance level may be replaced by a permissible loss of performance. If the minimum performance level or the permissible performance loss is not specified by the manufacturer, either of these may be derived from the product description and documentation, and from what the user may reasonably expect from the apparatus if used as intended..

Performance criterion B: The apparatus shall continue to operate as intended after the test. No degradation of performance or loss of function is allowed below a performance level specified by the manufacturer, when the apparatus is used as intended. The performance level may be replaced by a permissible loss of performance. During the test, degradation of performance is however allowed. No change of actual operating state or stored data is allowed. If the minimum performance level or the permissible performance loss is not specified by the manufacturer, either of these may be derived from the product description and documentation, and from what the user may reasonably expect from the apparatus if used as intended.

Performance criterion C: Temporary loss of function is allowed, provided the function is self-recoverable or can be restored by the operation of the controls.

2.2 Measurement Uncertainty

Where relevant, the following measurement uncertainty levels have been estimated for tests performed on the EUT as specified in CISPR 16-4-2:

| Measurement | Expanded Uncertainty (k=2) (\pm) | Maximum allowable uncertainty (\pm) |
|--|---|--|
| Conducted disturbance at mains port using AMN, 150kHz ~ 30MHz | 2.94 dB | 3.4 dB (U_{CISPR}) |
| Radiated disturbance, 30MHz ~ 1GHz | 4.30 dB | 6.3 dB (U_{CISPR}) |
| Radiated disturbance, 1GHz ~ 6GHz | 4.96 dB | 5.2 dB (U_{CISPR}) |

The other instruments specified are routine verified to remain within the calibrated levels, no measurement uncertainty is required to be calculated.

2.3 Modification Record

There were no modifications required for compliance.

3 General Information

3.1 Description of EUT

| | |
|---------------------|--|
| Product | Expandable Embedded Box PC |
| Brand | Vecow |
| Test Model | ECX-2200 |
| Series Model | ECX-2200 Series, ECX-2XXXXXXXXXXXXXXXXXXXXXXXXXXXXX ("X" can be 0-9, A-Z or blank for marketing purposes) |
| Model Difference | For marketing purpose |
| Sample Status | Engineering sample |
| Operating Software | Windows 10, Burnintest |
| Power Supply Rating | DC from Adapter |
| Accessory Device | N/A |
| Data Cable Supplied | N/A |

Note:

The EUT uses following adapter.

| | |
|--------------|--|
| Brand | LITEON |
| Model | PA-1121-24 |
| Input Power | 100-240Vac, 2.0A, 50-60Hz |
| Output Power | 24Vdc, 5A, 120W |
| Power Line | AC 3Pin Non-shielded DC cable (1.5m) with one ferrite core. |

3.2 Features of EUT

1. The tests reported herein were performed according to the method specified by Vecow Co., Ltd., for detailed feature description, please refer to the manufacturer's specifications or user's manual.
2. The EUT was configured with the following key components:

| Components | Brand | Model | Specification |
|------------|----------|-----------|--------------------------|
| CPU | Intel | i7-10700E | 2.9GHz |
| RAM | innodisk | - | DDR4 2666 8GB |
| SSD | Innodisk | - | 2.5" SATA SSD 3ME4 128GB |

3.3 Operating Modes of EUT and Determination of Worst Case Operating Mode

- The EUT is designed with AC power of rating 100-240Vac, 50-60Hz. For radiated emission evaluation, 230Vac/50Hz (for EN 50155), 120Vac/60Hz (for FCC Part 15) had been covered during the pre-test. The worst data was found at **120Vac/60Hz** and recorded in the applied test report.
- EUT has been pre-tested under following test modes, and test **mode 1** was the worst case for final test.

| Mode | Test Condition |
|------|--|
| 1 | Display* 2: 3840*2160, 60Hz + DVI: 1920*1080, 60Hz |
| 2 | Display* 2: 3840*2160, 60Hz + D-Sub: 1920*1080, 60Hz |

- Test modes are presented in the report as below.

| Mode | Test Condition | Input Power |
|--|--|--------------|
| Conducted emission test | | |
| 1 | Display* 2: 3840*2160, 60Hz + DVI: 1920*1080, 60Hz | 230Vac/ 50Hz |
| Radiated emission test | | |
| 1 | Display* 2: 3840*2160, 60Hz + DVI: 1920*1080, 60Hz | 120Vac/ 60Hz |
| Harmonics & Flicker and Immunity tests | | |
| 1 | Display* 2: 3840*2160, 60Hz + DVI: 1920*1080, 60Hz | 230Vac/ 50Hz |

3.4 Test Program Used and Operation Descriptions

Emission tests (Harmonics & Flicker excluded):

- a. Turned on the power of all equipment.
- b. EUT ran a test program to enable all functions.
- c. EUT read and wrote messages from/to SSD, Micro SD card and ext. SSDs.
- d. EUT sent and received messages to/from Notebook PCs (kept in a remote area) via two UTP LAN cables (10m each).
- e. EUT sent "H" messages to ext. LCD Monitors. Then they displayed "H" messages on their screens simultaneously.
- f. EUT sent messages to printer and printer printed them out.
- g. EUT sent 1kHz audio signal to earphone.
- h. Set the EUT under full resistor load.
- i. IP cameras captured video image to LCD Monitors via EUT.
- j. Steps c-i were repeated.

Harmonics, Flicker, Immunity tests:

- a. Turned on the power of all equipment.
- b. EUT ran a test program to enable all functions.
- c. EUT read and wrote messages from/to SSD and ext. SSDs.
- d. EUT sent and received messages to/from Notebook PCs (kept in a remote area) via two UTP LAN cables (10m each).
- e. EUT sent "color bars" messages to ext. LCD Monitors. Then they displayed "color bars" messages on their screens simultaneously.
- f. EUT sent audio signal to earphone.
- g. Set the EUT under full resistor load.
- h. IP cameras captured video image to LCD Monitors via EUT.
- i. Steps c-h were repeated.

3.5 Primary Clock Frequencies of Internal Source

The highest frequency generated or used within the EUT or on which the EUT operates or tunes is 2.9GHz, provided by Vecow Co., Ltd., for detailed internal source, please refer to the manufacturer's specifications.

4 Configuration and Connections with EUT

4.1 Connection Diagram of EUT and Peripheral Devices

Emission tests (Harmonics & Flicker excluded):

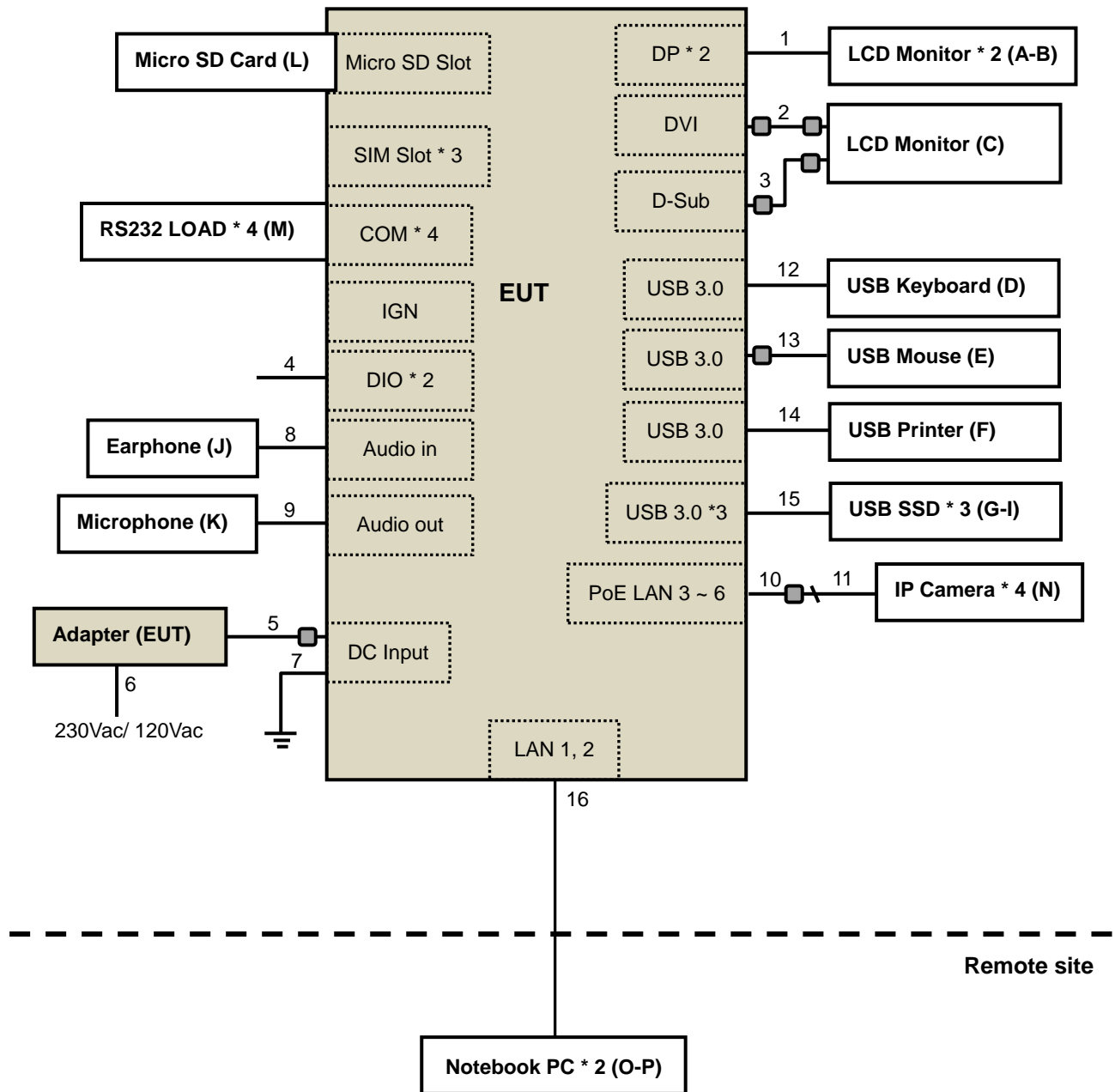

Harmonics & Flicker & Immunity tests:

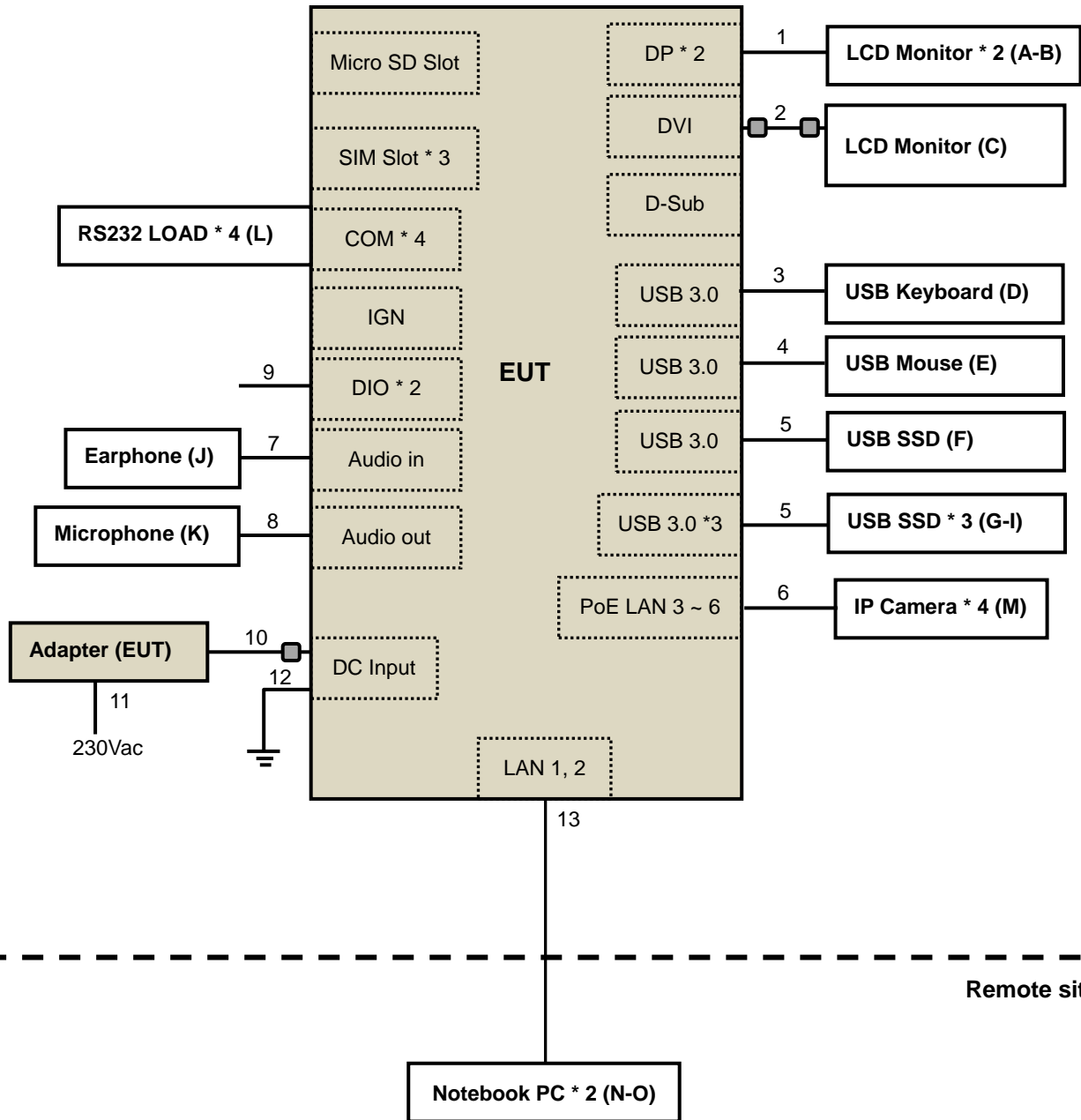

4.2 Configuration of Peripheral Devices and Cable Connections

Emission tests (Harmonics & Flicker excluded):

| ID | Product | Brand | Model No. | Serial No. | FCC ID | Remarks |
|----|----------------|-----------|---------------------------|------------------------------|------------------|--------------------|
| A. | LCD MONITOR | ASUS | VZ249 | J3LMRS008938 | NA | Provided by Lab |
| B. | LCD MONITOR | ASUS | MX27U | K1LMRS022990 | NA | Provided by Lab |
| C. | LCD MONITOR | DELL | U2410 | CN082WXD728720C C10NL | FCC DoC Approved | Provided by Lab |
| D. | USB Keyboard | Dell | KB216t | CN-0W33XP-LO300- 7CL-1909 | NA | Provided by Lab |
| E. | USB Mouse | Microsoft | 1113 | 9170528318308 | FCC DoC Approved | Provided by Lab |
| F. | USB Printer | HP | HP Officejet Pro 251dw | CN55FCV012 | FCC DoC Approved | Provided by Lab |
| G. | USB 3.1 SSD | WD | WDBK VX5120PS L | 1922MD401387 | NA | Supplied by client |
| H. | USB 3.1 SSD | WD | WDBK VX5120PS L | 1922MD401254 | NA | Provided by Lab |
| I. | USB 3.1 SSD | WD | WDBK VX5120PS L | 1922MD400948 | NA | Provided by Lab |
| J. | EARPHONE | PHILIPS | SBC HL145 | N/A | NA | Provided by Lab |
| K. | MICROPHONE | Labtec | mic-333 | N/A | NA | Provided by Lab |
| L. | Micro SD Card | SP | N/A | N/A | NA | Provided by Lab |
| M. | RS232 Load * 4 | NA | NA | NA | NA | Supplied by client |
| N. | IP Camera * 4 | NA | MBL030A-ORZ03 10 | NA | NA | Supplied by client |
| O. | Notebook PC | SONY | SVS151A12P | 275548477001024 | NA | Provided by Lab |
| P. | Notebook PC | ASUS | PU401L | ECNXBC012528528 | NA | Provided by Lab |

Note:

1. All power cords of the above support units are non-shielded (1.8m).
2. Items O-P acted as communication partners to transfer data.

| ID | Cable Descriptions | Qty. | Length (m) | Shielding (Yes/No) | Cores (Qty.) | Remarks |
|-----|--------------------|------|------------|--------------------|--------------|-----------------------------------|
| 1. | DP cable | 2 | 1.8 | Y | 0 | Provided by Lab |
| 2. | DVI cable | 1 | 1.8 | Y | 2 | Provided by Lab |
| 3. | D-Sub cable | 1 | 1.8 | Y | 2 | Provided by Lab |
| 4. | Signal cable | 2 | 0.4 | N | 0 | Provided by Lab |
| 5. | DC power cable | 1 | 1.5 | N | 1 | Supplied by client |
| 6. | AC power cable | 1 | 1.8 | N | 0 | Supplied by client |
| 7. | GND cable | 1 | 1.5 | N | 0 | Provided by Lab |
| 8. | Audio cable | 1 | 1.2 | N | 0 | Provided by Lab |
| 9. | Audio cable | 1 | 2.5 | N | 0 | Provided by Lab |
| 10. | LAN cable | 4 | 0.2 | N | 4 | Supplied by client (RJ45, Cat.5e) |
| 11. | LAN cable | 4 | 1.5 | N | 0 | Provided by Lab (RJ45, Cat.5e) |
| 12. | USB cable | 1 | 1.8 | Y | 0 | Provided by Lab |
| 13. | USB cable | 1 | 1.8 | Y | 1 | Provided by Lab |
| 14. | USB cable | 1 | 1.8 | Y | 0 | Provided by Lab |
| 15. | USB cable | 3 | 1.0 | Y | 0 | Provided by Lab |
| 16. | LAN cable | 2 | 10 | N | 0 | Provided by Lab (RJ45, Cat.5e) |

Note: The core(s) is(are) originally attached to the cable(s).

Harmonics, Flicker, Immunity tests:

| ID | Product | Brand | Model No. | Serial No. | FCC ID | Remarks |
|----|----------------|--------|---------------------|------------------------------|------------------|--------------------|
| A. | LCD MONITOR | DELL | P2418HZM | CN-079XVV-TV200-8 AM-06AT | NA | Provided by Lab |
| B. | LCD MONITOR | Vita | VT-270JTG2 | 204270JTFE002 | NA | Provided by Lab |
| C. | LCD MONITOR | Vita | VT-270JTG2 | 204270JTFE001 | NA | Provided by Lab |
| D. | USB Keyboard | HP | KU-1516 | NA | NA | Provided by Lab |
| E. | USB Mouse | Dell | MS111-P | NA | NA | Provided by Lab |
| F. | USB 3.1 SSD | WD | WDBK VX5120PS L | 1922MD400824 | FCC DoC Approved | Provided by Lab |
| G. | USB 3.1 SSD | WD | WDBK VX5120PS L | 1922JG400125 | NA | Supplied by client |
| H. | USB 3.1 SSD | WD | WDBK VX5120PS L | 1922JG400129 | NA | Provided by Lab |
| I. | USB 3.1 SSD | WD | WDBK VX5120PS L | 1922MD401110 | NA | Provided by Lab |
| J. | EARPHONE | N/A | NA | N/A | NA | Provided by Lab |
| K. | MICROPHONE | N/A | NA | N/A | NA | Provided by Lab |
| L. | RS232 Load * 4 | NA | NA | NA | NA | Supplied by client |
| M. | IP Camera * 4 | NA | MBL030A-ORZ03 10 | NA | NA | Supplied by client |
| N. | Notebook PC | LENOVO | TP00057A | R9-0JMLFS16/01 | NA | Provided by Lab |
| O. | Notebook PC | Lenovo | T470 | PF-0QW0NQ | NA | Provided by Lab |

Note:

1. All power cords of the above support units are non-shielded (1.8m).
2. Items N-O acted as communication partners to transfer data.

| ID | Cable Descriptions | Qty. | Length (m) | Shielding (Yes/No) | Cores (Qty.) | Remarks |
|-----|--------------------|------|------------|--------------------|--------------|--------------------------------|
| 1. | DP cable | 2 | 1.8 | Y | 0 | Provided by Lab |
| 2. | DVI cable | 1 | 1.8 | Y | 2 | Provided by Lab |
| 3. | USB cable | 1 | 1.8 | Y | 0 | Provided by Lab |
| 4. | USB cable | 1 | 1.8 | Y | 0 | Provided by Lab |
| 5. | USB cable | 4 | 0.3 | Y | 0 | Provided by Lab |
| 6. | LAN cable | 4 | 3.0 | N | 0 | Provided by Lab (RJ45, Cat.5e) |
| 7. | Audio cable | 1 | 1.0 | N | 0 | Provided by Lab |
| 8. | Audio cable | 1 | 1.0 | N | 0 | Provided by Lab |
| 9. | Signal cable | 2 | 0.4 | N | 0 | Supplied by client |
| 10. | DC power cable | 1 | 1.5 | N | 1 | Supplied by client |
| 11. | AC power cable | 1 | 1.8 | N | 0 | Supplied by client |
| 12. | GND cable | 1 | 3.0 | N | 0 | Provided by Lab |
| 13. | LAN cable | 2 | 3.0 | N | 0 | Provided by Lab (RJ45, Cat.5e) |

Note: The core(s) is(are) originally attached to the cable(s).

5 Conducted Disturbance at Auxiliary a.c. or d.c. Power Ports

5.1 Limits

| Frequency (MHz) | Quasi-peak, (dBuV) |
|-----------------|--------------------|
| 0.15 - 0.5 | 99 |
| 0.5 - 30 | 93 |

Notes: 1. The lower limit shall apply at the transition frequencies.
 2. The limit decreases linearly with the logarithm of the frequency in the range of 0.15 to 0.50 MHz.

5.2 Test Instruments

| Description & Manufacturer | Model No. | Serial No. | Cal. Date | Cal. Due |
|--|---------------|--------------|---------------|---------------|
| ROHDE & SCHWARZ TEST RECEIVER | ESR3 | 102413 | Feb. 8, 2021 | Feb. 7, 2022 |
| ROHDE & SCHWARZ Artificial Mains Network (for EUT) | ESH2-Z5 | 100104 | Dec. 18, 2020 | Dec. 17, 2021 |
| LISN With Adapter (for EUT) | AD10 | C09Ada-001 | Dec. 8, 2020 | Dec. 7, 2021 |
| ROHDE & SCHWARZ Artificial Mains Network (for peripherals) | ESH3-Z5 | 847265/023 | Nov. 11, 2020 | Nov. 10, 2021 |
| SCHWARZBECK Artificial Mains Network (For EUT) | NNLK8129 | 8129229 | May 14, 2020 | May 13, 2021 |
| SCHWARZBECK Artificial Mains Network (for EUT) | NNLK 8121 | 8121-808 | Apr. 10, 2020 | Apr. 9, 2021 |
| Software | Cond_V7.3.7.4 | NA | NA | NA |
| RF cable (JYEBAO) With 10dB PAD | 5D-FB | Cable-C09.01 | Aug. 14, 2020 | Aug. 13, 2021 |
| LYNICS Terminator (For ROHDE & SCHWARZ LISN) | 0900510 | E1-01-299 | Jan. 27, 2021 | Jan. 26, 2022 |

Note: 1. The calibration interval of the above test instruments is 12 months and the calibrations are traceable to NML/ROC and NIST/USA.
 2. The test was performed in Shielded Room No. 9. (Conduction 9)
 3. The VCCI Site Registration No. C-11312.
 4. Tested Date: Mar. 15, 2021

5.3 Test Arrangement

- The EUT was placed 0.4 meters from the conducting wall of the shielded room with EUT being connected to the power mains through a line impedance stabilization network (LISN). Other support units were connected to the power mains through another LISN. The two LISNs provide 50 Ohm/ 50uH of coupling impedance for the measuring instrument.
- Both lines of the power mains connected to the EUT were checked for maximum conducted interference.
- The test results of conducted emissions at mains ports are recorded of six worst margins for quasi-peak (mandatory) [and average (if necessary)] values against the limits at frequencies of interest unless the margin is 20 dB or greater.

Note: The resolution bandwidth and video bandwidth of test receiver is 9kHz for quasi-peak detection (QP) and average detection (AV) at frequency 0.15MHz-30MHz.

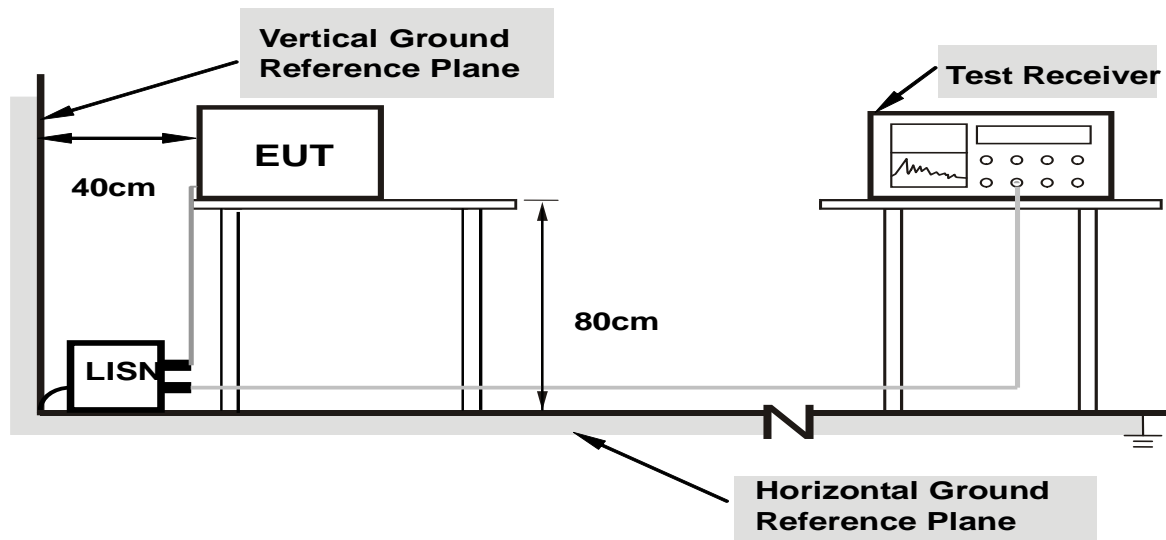

Note: Support units were connected to second LISN.

For the actual test configuration, please refer to the related item – Photographs of the Test Configuration.

5.4 Test Results

| | | | |
|------------------------|----------------|--|-----------------------|
| Frequency Range | 150kHz ~ 30MHz | Detector Function & Bandwidth | Quasi-Peak (QP), 9kHz |
| Input Power | 230Vac, 50Hz | Environmental Conditions | 21°C, 65%RH |
| Tested by | Vhenson Huang | Test Date | 2021/3/15 |
| Test Mode | Mode 1 | | |

| Phase Of Power : Line (L) | | | | | | |
|---------------------------|-----------------|------------------------|----------------------|-----------------------|--------------|-------------|
| No | Frequency (MHz) | Correction Factor (dB) | Reading Value (dBuV) | Emission Level (dBuV) | Limit (dBuV) | Margin (dB) |
| | | | Q.P. | Q.P. | Q.P. | Q.P. |
| 1 | 0.49324 | 10.23 | 29.17 | 39.40 | 99.00 | -59.60 |
| 2 | 0.69837 | 10.25 | 29.73 | 39.98 | 93.00 | -53.02 |
| 3 | 0.89501 | 10.27 | 26.65 | 36.92 | 93.00 | -56.08 |
| 4 | 1.30913 | 10.30 | 21.14 | 31.44 | 93.00 | -61.56 |
| 5 | 7.57735 | 10.63 | 27.57 | 38.20 | 93.00 | -54.80 |
| 6 | 16.46314 | 11.02 | 27.51 | 38.53 | 93.00 | -54.47 |

Remarks:

1. Q.P. and AV. are abbreviations of quasi-peak and average individually.
2. The emission levels of other frequencies were very low against the limit.
3. Margin value = Emission level – Limit value
4. Correction factor = Insertion loss + Cable loss
5. Emission Level = Correction Factor + Reading Value

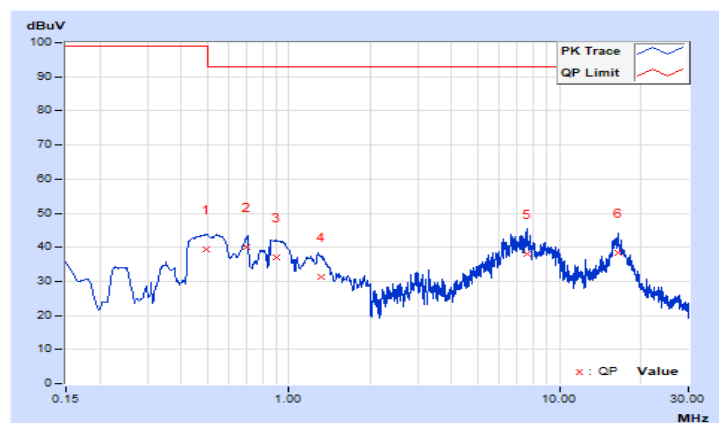

| | | | |
|------------------------|----------------|--|-----------------------|
| Frequency Range | 150kHz ~ 30MHz | Detector Function & Bandwidth | Quasi-Peak (QP), 9kHz |
| Input Power | 230Vac, 50Hz | Environmental Conditions | 21°C, 65%RH |
| Tested by | Vhenson Huang | Test Date | 2021/3/15 |
| Test Mode | Mode 1 | | |

| Phase Of Power : Neutral (N) | | | | | | |
|------------------------------|-----------------|------------------------|----------------------|-----------------------|--------------|---------------|
| No | Frequency (MHz) | Correction Factor (dB) | Reading Value (dBuV) | Emission Level (dBuV) | Limit (dBuV) | Margin (dB) |
| | | | Q.P. | Q.P. | Q.P. | Q.P. |
| 1 | 0.23213 | 10.21 | 22.49 | 32.70 | 99.00 | -66.30 |
| 2 | 0.55096 | 10.25 | 26.87 | 37.12 | 93.00 | -55.88 |
| 3 | 0.70581 | 10.26 | 28.25 | 38.51 | 93.00 | -54.49 |
| 4 | 0.88299 | 10.27 | 25.60 | 35.87 | 93.00 | -57.13 |
| 5 | 7.08456 | 10.60 | 29.79 | 40.39 | 93.00 | -52.61 |
| 6 | 16.22848 | 10.87 | 22.82 | 33.69 | 93.00 | -59.31 |

Remarks:

1. Q.P. and AV. are abbreviations of quasi-peak and average individually.
2. The emission levels of other frequencies were very low against the limit.
3. Margin value = Emission level – Limit value
4. Correction factor = Insertion loss + Cable loss
5. Emission Level = Correction Factor + Reading Value

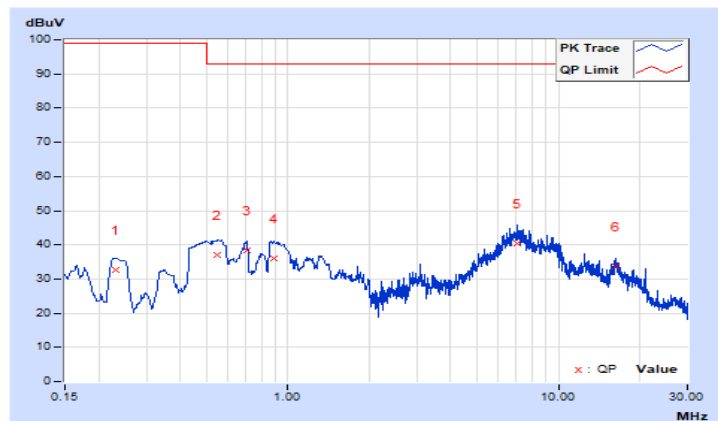

6 Radiated Disturbance up to 1 GHz

6.1 Limits

| Frequency (MHz) | dBuV/m (at 10m) / quasi-peak |
|-----------------|------------------------------|
| 30 - 230 | 40 |
| 230 - 1000 | 47 |

- Notes:
1. The lower limit shall apply at the transition frequencies.
 2. Emission level (dBuV/m) = 20 log Emission level (uV/m).
 3. All emanations from a class A/B digital device or system, including any network of conductors and apparatus connected thereto, shall not exceed the level of field strengths specified above.

6.2 Test Instruments

| Description & Manufacturer | Model No. | Serial No. | Cal. Date | Cal. Due |
|----------------------------------|----------------------|--------------|---------------|---------------|
| ROHDE & SCHWARZ TEST RECEIVER | ESCS 30 | 100027 | May 19, 2020 | May 18, 2021 |
| Schwarzbeck Bilog Antenna | VULB9168 | 9168-303 | Nov. 5, 2020 | Nov. 4, 2021 |
| Agilent Preamplifier | 8447D | 2944A08119 | Feb. 18, 2021 | Feb. 17, 2022 |
| ADT. Turn Table | TT100 | 0205 | NA | NA |
| ADT. Tower | AT100 | 0205 | NA | NA |
| Software | Radiated_V7.6.15.9.5 | NA | NA | NA |
| ADT RF Switches BOX | EMH-011 | 1001 | Oct. 23, 2020 | Oct. 22, 2021 |
| Pacific RF cable With 5dB PAD | 8D | CABLE-ST2-01 | Oct. 23, 2020 | Oct. 22, 2021 |

- Note:
1. The calibration interval of the above test instruments is 12 months and the calibrations are traceable to NML/ROC and NIST/USA.
 2. The test was performed in Open Site No. 2.
 3. The VCCI Site Registration No. R-10237.
 4. Tested Date: Mar. 19, 2021

6.3 Test Arrangement

- The EUT was placed on the top of a rotating table 0.8 meters above the ground at an accredited test facility. The table was rotated 360 degrees to determine the position of the highest radiation.
- The EUT was set 10 meters away from the interference-receiving antenna, which was mounted on the top of a variable-height antenna tower.
- The antenna is a broadband antenna, and its height is varied from one meter to four meters above the ground to determine the maximum value of the field strength. Both horizontal and vertical polarizations of the antenna are set to make the measurement.
- For each suspected emission, the EUT was arranged to its worst case and then the antenna was tuned to heights from 1 meter to 4 meters and the rotatable table was turned from 0 degrees to 360 degrees to find the maximum reading.
- The test-receiver system was set to quasi-peak detect function and specified bandwidth with maximum hold mode when the test frequency is up to 1 GHz.

Note: The resolution bandwidth and video bandwidth of test receiver/spectrum analyzer is 120kHz for quasi-peak detection (QP) at frequency up to 1GHz.

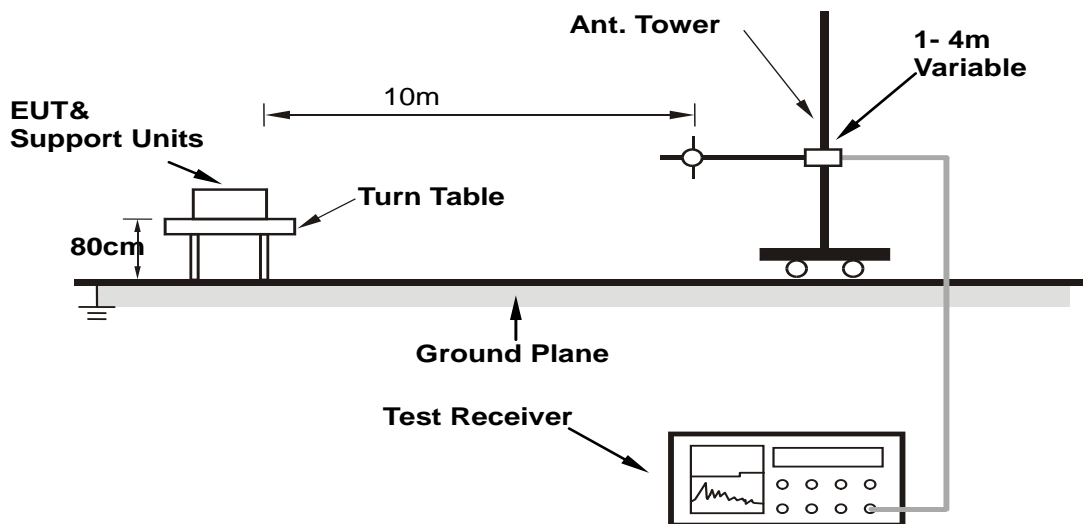

For the actual test configuration, please refer to the related item – Photographs of the Test Configuration.

6.4 Test Results

| | | | |
|------------------------|--------------|---|-------------------------|
| Frequency Range | 30MHz ~ 1GHz | Detector Function & Resolution Bandwidth | Quasi-Peak (QP), 120kHz |
| Tested By | Paul Chen | Environmental Conditions | 21.0°C, 73.0%RH |
| Test Mode | Mode 1 | Test Date | 2021/3/19 |

Antenna Polarity & Test Distance : Horizontal at 10 m

| No | Frequency (MHz) | Emission Level (dBuV/m) | Limit (dBuV/m) | Margin (dB) | Antenna Height (m) | Table Angle (Degree) | Raw Value (dBuV) | Correction Factor (dB/m) |
|----------|-----------------|-------------------------|----------------|--------------|--------------------|----------------------|------------------|--------------------------|
| 1 | 84.37 | 28.44 QP | 40.00 | -11.56 | 4.00 H | 342 | 44.11 | -15.67 |
| 2 | 124.99 | 28.08 QP | 40.00 | -11.92 | 4.00 H | 288 | 39.27 | -11.19 |
| 3 | 138.37 | 30.71 QP | 40.00 | -9.29 | 4.00 H | 266 | 40.52 | -9.81 |
| 4 | 189.04 | 33.80 QP | 40.00 | -6.20 | 4.00 H | 334 | 45.68 | -11.88 |
| 5 | 216.00 | 34.47 QP | 40.00 | -5.53 | 4.00 H | 142 | 46.43 | -11.96 |
| 6 | 297.12 | 33.56 QP | 47.00 | -13.44 | 3.83 H | 214 | 41.45 | -7.89 |
| 7 | 324.15 | 38.57 QP | 47.00 | -8.43 | 3.14 H | 234 | 45.55 | -6.98 |
| 8 | 461.98 | 35.97 QP | 47.00 | -11.03 | 2.22 H | 106 | 40.13 | -4.16 |
| 9 | 500.00 | 39.45 QP | 47.00 | -7.55 | 1.93 H | 97 | 42.93 | -3.48 |
| 10 | 550.14 | 38.30 QP | 47.00 | -8.70 | 1.87 H | 262 | 40.88 | -2.58 |
| 11 | 600.01 | 35.84 QP | 47.00 | -11.16 | 1.45 H | 97 | 36.96 | -1.12 |
| 12 | 924.01 | 40.45 QP | 47.00 | -6.55 | 1.00 H | 104 | 34.73 | 5.72 |
| 13 | 960.00 | 34.92 QP | 47.00 | -12.08 | 1.00 H | 133 | 28.65 | 6.27 |

Remarks:

1. Emission Level(dBuV/m) = Raw Value(dBuV) + Correction Factor(dB/m)
2. Correction Factor(dB/m) = Antenna Factor (dB/m) + Cable Factor (dB)
– Pre-Amplifier Factor (dB)
3. The other emission levels were very low against the limit.
4. Margin value = Emission level – Limit value

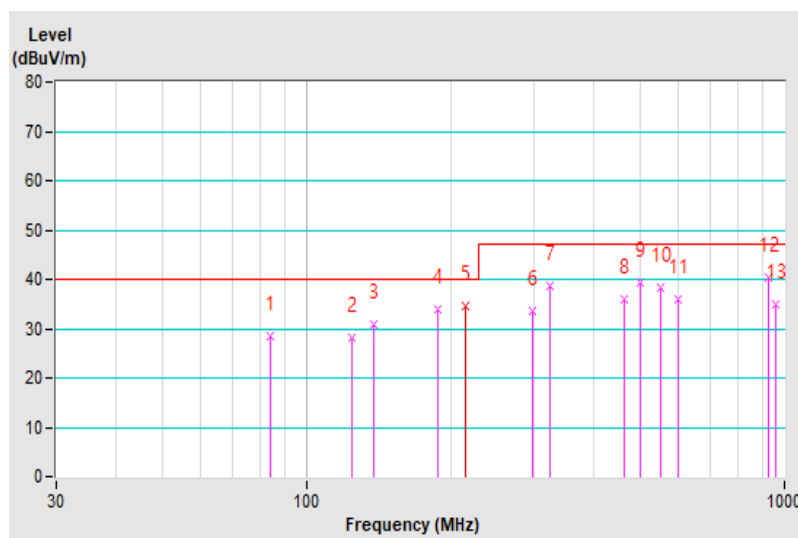

| | | | |
|------------------------|--------------|---|-------------------------|
| Frequency Range | 30MHz ~ 1GHz | Detector Function & Resolution Bandwidth | Quasi-Peak (QP), 120kHz |
| Tested By | Paul Chen | Environmental Conditions | 21.0°C, 73.0%RH |
| Test Mode | Mode 1 | Test Date | 2021/3/19 |

| Antenna Polarity & Test Distance : Vertical at 10 m | | | | | | | | |
|---|-----------------|-------------------------|----------------|-------------|--------------------|----------------------|------------------|--------------------------|
| No | Frequency (MHz) | Emission Level (dBuV/m) | Limit (dBuV/m) | Margin (dB) | Antenna Height (m) | Table Angle (Degree) | Raw Value (dBuV) | Correction Factor (dB/m) |
| 1 | 79.88 | 30.41 QP | 40.00 | -9.59 | 1.64 V | 174 | 45.26 | -14.85 |
| 2 | 95.65 | 28.47 QP | 40.00 | -11.53 | 1.00 V | 51 | 43.51 | -15.04 |
| 3 | 139.25 | 30.70 QP | 40.00 | -9.30 | 1.00 V | 321 | 40.53 | -9.83 |
| 4 | 154.00 | 29.83 QP | 40.00 | -10.17 | 1.00 V | 310 | 38.97 | -9.14 |
| 5 | 189.04 | 33.78 QP | 40.00 | -6.22 | 1.00 V | 1 | 45.66 | -11.88 |
| 6 | 222.08 | 34.27 QP | 40.00 | -5.73 | 1.00 V | 107 | 46.06 | -11.79 |
| 7 | 250.01 | 30.14 QP | 47.00 | -16.86 | 1.00 V | 116 | 39.94 | -9.80 |
| 8 | 324.15 | 36.49 QP | 47.00 | -10.51 | 1.00 V | 159 | 43.47 | -6.98 |
| 9 | 480.00 | 37.12 QP | 47.00 | -9.88 | 1.00 V | 251 | 41.06 | -3.94 |
| 10 | 500.00 | 32.99 QP | 47.00 | -14.01 | 1.00 V | 292 | 36.47 | -3.48 |
| 11 | 600.00 | 34.50 QP | 47.00 | -12.50 | 3.13 V | 241 | 35.62 | -1.12 |
| 12 | 924.00 | 39.91 QP | 47.00 | -7.09 | 2.23 V | 198 | 34.19 | 5.72 |
| 13 | 960.00 | 36.80 QP | 47.00 | -10.20 | 2.16 V | 1 | 30.53 | 6.27 |

Remarks:

1. Emission Level(dBuV/m) = Raw Value(dBuV) + Correction Factor(dB/m)
2. Correction Factor(dB/m) = Antenna Factor (dB/m) + Cable Factor (dB)
– Pre-Amplifier Factor (dB)
3. The other emission levels were very low against the limit.
4. Margin value = Emission level – Limit value

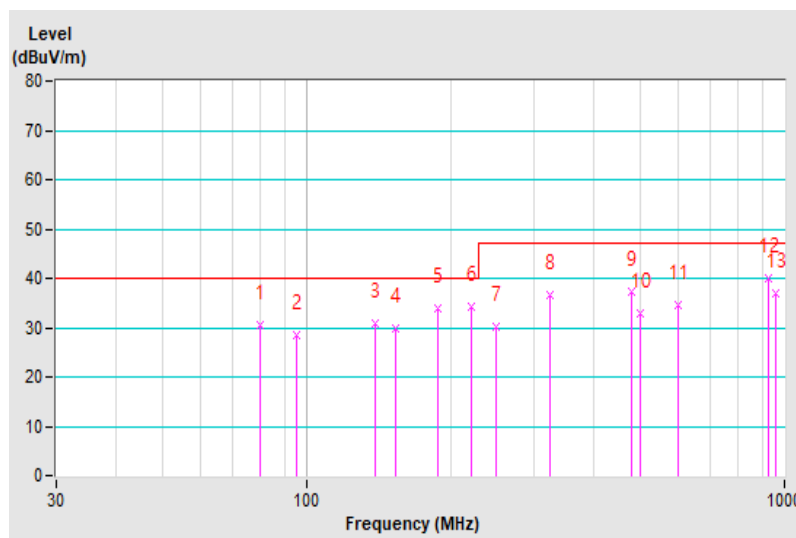

7 Radiated Disturbance above 1 GHz

7.1 Limits

| Frequency (GHz) | dBuV/m (at 3m) | |
|-----------------|----------------|------|
| | Average | Peak |
| 1 to 3 | 56 | 76 |
| 3 to 6 | 60 | 80 |

- Notes: 1. The lower limit shall apply at the transition frequencies.
 2. Emission level (dBuV/m) = 20 log Emission level (uV/m).
 3. All emanations from a class A/B digital device or system, including any network of conductors and apparatus connected thereto, shall not exceed the level of field strengths specified above.

Frequency Range (For unintentional radiators)

| Highest frequency generated or used in the EUT or on which the EUT operates or tunes (MHz) | Upper frequency of measurement range (MHz) |
|--|--|
| Below 108 | 1000 |
| 108-500 | 2000 |
| 500-1000 | 5000 |
| Above 1000 | Up to 5 times of the highest frequency or 6 GHz, whichever is less |

7.2 Test Instruments

| Description & Manufacturer | Model No. | Serial No. | Cal. Date | Cal. Due |
|-----------------------------------|---------------------|----------------|---------------|---------------|
| Agilent Spectrum | E4446A | MY51100009 | Jun. 23, 2020 | Jun. 22, 2021 |
| Agilent Test Receiver | N9038A | MY50010135 | May 29, 2020 | May 28, 2021 |
| EMCI Preamplifier | EMC0126545 | 980076 | Feb. 19, 2021 | Feb. 18, 2022 |
| MITEQ Preamplifier | AMF-6F-260400-33-8P | 892164 | Feb. 19, 2021 | Feb. 18, 2022 |
| EMCI Preamplifier | EMC184045B | 980235 | Feb. 19, 2021 | Feb. 18, 2022 |
| ETS Preamplifier | 3117-PA | 00215857 | Nov. 23, 2020 | Nov. 22, 2021 |
| Schwarzbeck Horn Antenna | BBHA-9170 | 212 | Nov. 22, 2020 | Nov. 21, 2021 |
| EMCO Horn Antenna | 3115 | 9312-4192 | Nov. 22, 2020 | Nov. 21, 2021 |
| Max Full. Turn Table & Tower | MF7802 | MF780208103 | NA | NA |
| Software | Radiated_V8.7.08 | NA | NA | NA |
| SUHNER RF cable With 3/4dB PAD | SF102 | Cable-CH7-3.6m | Jul. 9, 2020 | Jul. 8, 2021 |
| MICRO-TRONICS Notch filter | BRC50703-01 | 010 | May 29, 2020 | May 28, 2021 |
| MICRO-TRONICS Band Pass Filter | BRM17690 | 005 | May 29, 2020 | May 28, 2021 |

- Note: 1. The calibration interval of the above test instruments is 12 months and the calibrations are traceable to NML/ROC and NIST/USA.
 2. The 3dB beamwidth of the horn antenna is minimum 40 degree (or w = 2.18m at 3m distance) for 1~6 GHz.
 3. The test was performed in Chamber No. 7.
 4. The VCCI Site Registration No. G-10039
 5. Tested Date: Mar. 24, 2021

7.3 Test Arrangement

- The EUT was placed on the top of a rotating table 0.8 meters above the ground at an accredited chamber room. The table was rotated 360 degrees to determine the position of the highest radiation.
- The EUT was set 3 meters away from the interference-receiving antenna, which was mounted on the top of a variable-height antenna tower.
- The height of antenna can be varied from one meter to four meters, the height of adjustment depends on the EUT height and the antenna 3dB beamwidth both, to detect the maximum value of the field strength. Both horizontal and vertical polarizations of the antenna are set to make the measurement.
- For each suspected emission, the EUT was arranged to its worst case and then the antenna was tuned to heights and the rotatable table was turned from 0 degrees to 360 degrees to find the maximum reading.
- The spectrum analyzer system was set to peak and average detect function and specified bandwidth with maximum hold mode when the test frequency is above 1 GHz.

Note: The resolution bandwidth of test receiver/spectrum analyzer is 1MHz and video bandwidth is 3MHz for Peak detection (PK) at frequency above 1GHz. The resolution bandwidth of test receiver/spectrum analyzer is 1 MHz for Average detection (AV) at frequency above 1GHz.

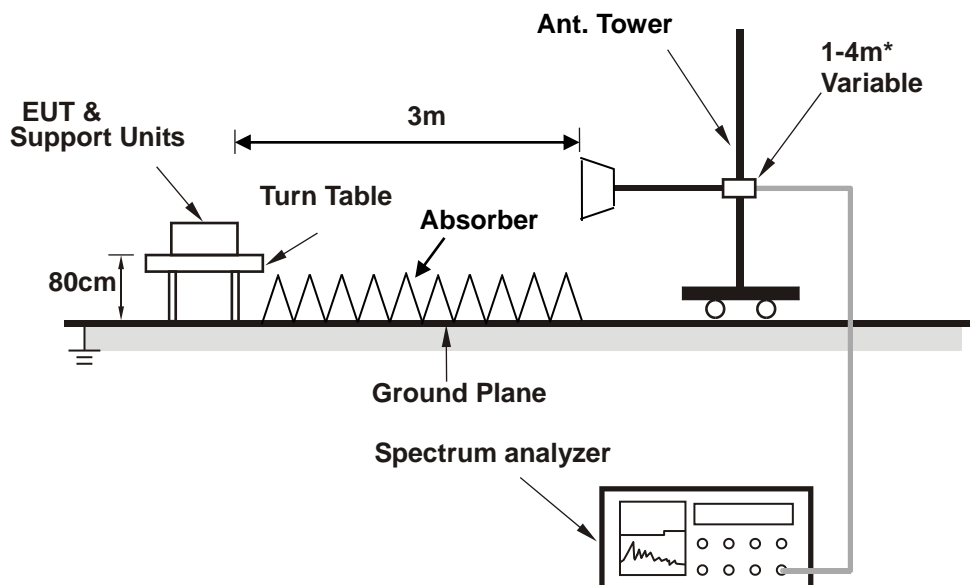

* :depends on the EUT height and the antenna 3dB beamwidth both.

For the actual test configuration, please refer to the related item – Photographs of the Test Configuration.

7.4 Test Results

| | | | |
|------------------------|---------------|---|--------------------------------|
| Frequency Range | 1GHz ~ 6GHz | Detector Function & Resolution Bandwidth | Peak (PK) / Average (AV), 1MHz |
| Tested By | Chin-Wen Wang | Environmental Conditions | 23.0°C, 68.0%RH |
| Test Mode | Mode 1 | Test Date | 2021/3/24 |

| Antenna Polarity & Test Distance : Horizontal at 3 m | | | | | | | | |
|--|-----------------|-------------------------|----------------|-------------|--------------------|----------------------|------------------|--------------------------|
| No | Frequency (MHz) | Emission Level (dBuV/m) | Limit (dBuV/m) | Margin (dB) | Antenna Height (m) | Table Angle (Degree) | Raw Value (dBuV) | Correction Factor (dB/m) |
| 1 | 1774.35 | 51.81 PK | 76.00 | -24.19 | 2.20 H | 297 | 53.12 | -1.31 |
| 2 | 1774.35 | 32.58 AV | 56.00 | -23.42 | 2.20 H | 297 | 33.89 | -1.31 |
| 3 | 2161.95 | 52.10 PK | 76.00 | -23.90 | 1.00 H | 177 | 51.36 | 0.74 |
| 4 | 2161.95 | 34.99 AV | 56.00 | -21.01 | 1.00 H | 177 | 34.25 | 0.74 |
| 5 | 2309.85 | 57.34 PK | 76.00 | -18.66 | 1.17 H | 276 | 56.37 | 0.97 |
| 6 | 2309.85 | 44.60 AV | 56.00 | -11.40 | 1.17 H | 276 | 43.63 | 0.97 |
| 7 | 2736.55 | 50.97 PK | 76.00 | -25.03 | 1.00 H | 236 | 49.58 | 1.39 |
| 8 | 2736.55 | 33.91 AV | 56.00 | -22.09 | 1.00 H | 236 | 32.52 | 1.39 |
| 9 | 4979.27 | 51.48 PK | 80.00 | -28.52 | 1.94 H | 185 | 45.60 | 5.88 |
| 10 | 4979.27 | 36.73 AV | 60.00 | -23.27 | 1.94 H | 185 | 30.85 | 5.88 |

Remarks:

1. Emission Level(dBuV/m) = Raw Value(dBuV) + Correction Factor(dB/m)
2. Correction Factor(dB/m) = Antenna Factor (dB/m) + Cable Factor (dB) – Pre-Amplifier Factor (dB)
3. The other emission levels were very low against the limit.
4. Margin value = Emission level – Limit value

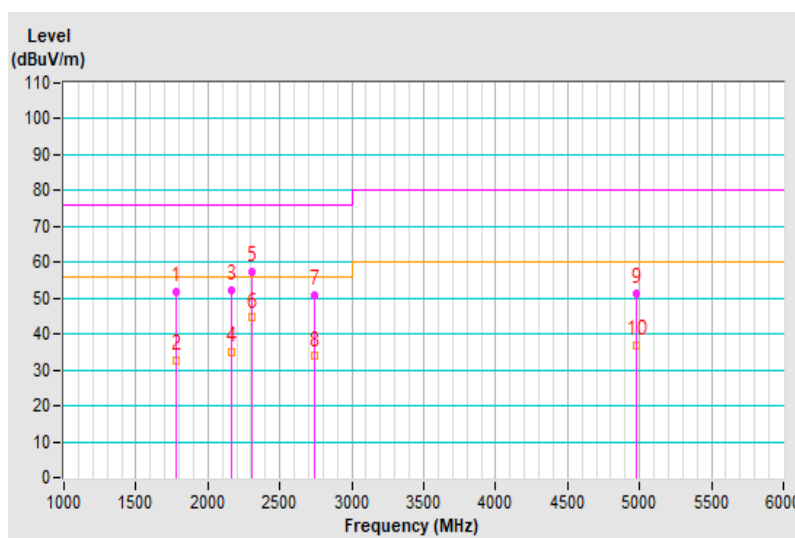

| | | | |
|------------------------|---------------|---|--------------------------------|
| Frequency Range | 1GHz ~ 6GHz | Detector Function & Resolution Bandwidth | Peak (PK) / Average (AV), 1MHz |
| Tested By | Chin-Wen Wang | Environmental Conditions | 23.0°C, 68.0%RH |
| Test Mode | Mode 1 | Test Date | 2021/3/24 |

| Antenna Polarity & Test Distance : Vertical at 3 m | | | | | | | | |
|--|-----------------|-------------------------|----------------|--------------|--------------------|----------------------|------------------|--------------------------|
| No | Frequency (MHz) | Emission Level (dBuV/m) | Limit (dBuV/m) | Margin (dB) | Antenna Height (m) | Table Angle (Degree) | Raw Value (dBuV) | Correction Factor (dB/m) |
| 1 | 1999.17 | 52.51 PK | 76.00 | -23.49 | 1.02 V | 59 | 51.45 | 1.06 |
| 2 | 1999.17 | 35.36 AV | 56.00 | -20.64 | 1.02 V | 59 | 34.30 | 1.06 |
| 3 | 2156.00 | 56.12 PK | 76.00 | -19.88 | 1.54 V | 190 | 55.40 | 0.72 |
| 4 | 2156.00 | 42.14 AV | 56.00 | -13.86 | 1.54 V | 190 | 41.42 | 0.72 |
| 5 | 2309.85 | 59.73 PK | 76.00 | -16.27 | 2.29 V | 304 | 58.76 | 0.97 |
| 6 | 2309.85 | 46.54 AV | 56.00 | -9.46 | 2.29 V | 304 | 45.57 | 0.97 |
| 7 | 2761.20 | 59.28 PK | 76.00 | -16.72 | 1.27 V | 190 | 57.84 | 1.44 |
| 8 | 2761.20 | 36.50 AV | 56.00 | -19.50 | 1.27 V | 190 | 35.06 | 1.44 |
| 9 | 4997.55 | 53.45 PK | 80.00 | -26.55 | 1.75 V | 301 | 47.52 | 5.93 |
| 10 | 4997.55 | 38.74 AV | 60.00 | -21.26 | 1.75 V | 301 | 32.81 | 5.93 |

Remarks:

1. Emission Level(dBuV/m) = Raw Value(dBuV) + Correction Factor(dB/m)
2. Correction Factor(dB/m) = Antenna Factor (dB/m) + Cable Factor (dB) – Pre-Amplifier Factor (dB)
3. The other emission levels were very low against the limit.
4. Margin value = Emission level – Limit value

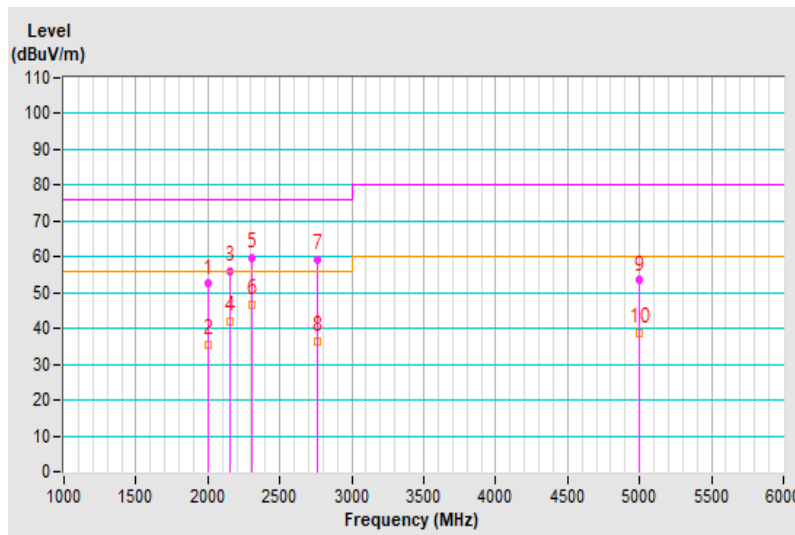

8 Harmonics Current Measurement

8.1 Limits

| Limits for Class A equipment | | Limits for Class D equipment | | |
|------------------------------|--------------------------------------|------------------------------|--|--------------------------------------|
| Harmonic Order n | Max. permissible harmonics current A | Harmonic Order n | Max. permissible harmonics current per watt mA/W | Max. permissible harmonics current A |
| Odd harmonics | | Odd Harmonics only | | |
| 3 | 2.30 | 3 | 3.4 | 2.30 |
| 5 | 1.14 | 5 | 1.9 | 1.14 |
| 7 | 0.77 | 7 | 1.0 | 0.77 |
| 9 | 0.40 | 9 | 0.5 | 0.40 |
| 11 | 0.33 | 11 | 0.35 | 0.33 |
| 13 | 0.21 | 13 | 0.30 | 0.21 |
| 15 ≤ n ≤ 39 | 0.15 x 15/n | 15 ≤ n ≤ 39 | 3.85/n | 0.15 x 15/n |
| Even harmonics | | | | |
| 2 | 1.08 | | | |
| 4 | 0.43 | | | |
| 6 | 0.30 | | | |
| 8 ≤ n ≤ 40 | 0.23 x 8/n | | | |

Notes: 1. Class A and Class D are classified according to section 5 of EN 61000-3-2.

2. According to section 7 of EN 61000-3-2, the above limits for all equipment except for lighting equipment having an active input power > 75 W and no limits apply for equipment with an active input power up to and including 75 W.

8.2 Classification of Equipment

| Class A | Class B | Class C | Class D |
|--|--|---------------------|---|
| Balanced three-phase equipment; Household appliances excluding equipment as Class D; Tools excluding portable tools; Dimmers for incandescent lamps; Audio equipment; Equipment not specified in one of the three other classes. | Portable tools; Arc welding equipment which is not professional equipment. | Lighting equipment. | Equipment having a specified power less than or equal to 600 W of the following types: Personal computers and personal computer monitors; Television receivers; Refrigerators and freezers having one or more variable-speed drives to control compressor motor(s). |

8.3 Test Instruments

| Description & Manufacturer | Model No. | Serial No. | Cal. Date | Cal. Due |
|---------------------------------------|--------------|-----------------------|---------------|---------------|
| Teseq Harmonics - Flicker Test System | Proflin 2105 | 32A00983 & 1639A01863 | Sep. 16, 2020 | Sep. 15, 2021 |
| Software | CTS 4 | NA | NA | NA |

- Note: 1. The calibration interval of the above test instruments is 12 months and the calibrations are traceable to NML/ROC and NIST/USA.
 2. The test was performed in EMS Room No. 1.
 3. According to IEC 61000-4-7: 2002, the time window shall be synchronized with each group of 10 or 12 cycles (200 ms) for power frequency of 50 or 60Hz.
 4. Tested Date: Mar. 26, 2021

8.4 Test Arrangement

- a. The EUT was placed on the top of a wooden table 0.8 meters above the ground and operated to produce the maximum harmonic components under normal operating conditions for each successive harmonic component in turn.
- b. The correspondent test program of test instrument to measure the current harmonics emanated from EUT is chosen. The measure time shall be not less than the time necessary for the EUT to be exercised.

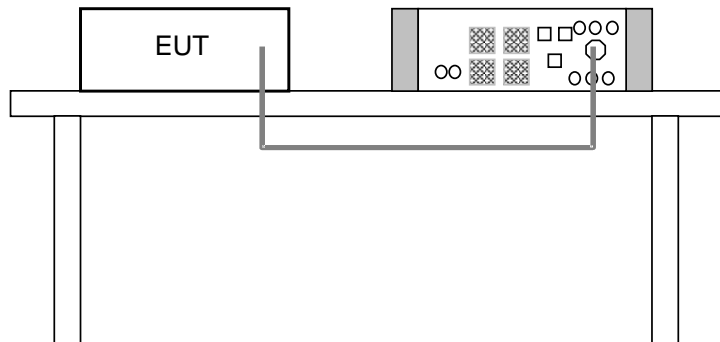

For the actual test configuration, please refer to the related item – Photographs of the Test Configuration.

8.5 Test Results

| | | | |
|----------------------------|--------------------------|-----------------|------------|
| Fundamental Voltage/Ampere | 230.51Vrms/ 0.565Arms | Power Frequency | 50.00Hz |
| Power Consumption | 117.2W | Power Factor | 0.902 |
| Environmental Conditions | 20°C, 82% RH | Tested by | Chiming Li |
| Test Mode | Mode 1 | Test Date | 2021/3/26 |

| Harm# | Harms (avg) (A) | 100% Limit (A) | Harms (max) (A) | 150% Limit (A) | Test Result |
|-------|--------------------|-------------------|--------------------|-------------------|-------------|
| 3 | 0.161 | 0.399 | 0.179 | 0.598 | Pass |
| 5 | 0.035 | 0.223 | 0.040 | 0.334 | Pass |
| 7 | 0.023 | 0.117 | 0.027 | 0.176 | Pass |
| 9 | 0.002 | 0.059 | 0.005 | 0.088 | Pass |
| 11 | 0.006 | 0.041 | 0.008 | 0.062 | Pass |
| 13 | 0.007 | 0.035 | 0.007 | 0.053 | Pass |
| 15 | 0.008 | 0.030 | 0.010 | 0.046 | Pass |
| 17 | 0.006 | 0.027 | 0.007 | 0.040 | Pass |
| 19 | 0.002 | 0.024 | 0.004 | 0.036 | Pass |
| 21 | 0.011 | 0.021 | 0.012 | 0.032 | Pass |
| 23 | 0.006 | 0.020 | 0.007 | 0.029 | Pass |
| 25 | 0.008 | 0.018 | 0.009 | 0.027 | Pass |
| 27 | 0.004 | 0.017 | 0.010 | 0.025 | Pass |
| 29 | 0.007 | 0.016 | 0.011 | 0.023 | Pass |
| 31 | 0.003 | 0.015 | 0.004 | 0.022 | Pass |
| 33 | 0.005 | 0.014 | 0.006 | 0.020 | Pass |
| 35 | 0.004 | 0.013 | 0.006 | 0.019 | Pass |
| 37 | 0.003 | 0.012 | 0.004 | 0.018 | Pass |
| 39 | 0.161 | 0.399 | 0.179 | 0.598 | Pass |

Note: Dynamic limits were applied for this test. The highest harmonics values in the above table may not occur at the same window as the maximum harmonics/limit ratio.

9 Voltage Fluctuations and Flicker Measurement

9.1 Limits

| Test item | Limit | Note |
|----------------|-------|---|
| P_{st} | 1.0 | P_{st} : short-term flicker severity. |
| P_{lt} | 0.65 | P_{lt} : long-term flicker severity. |
| T_{max} (ms) | 500 | T_{max} : maximum time duration during the observation period that the voltage deviation $d(t)$ exceeds the limit for d_c . |
| d_{max} (%) | 4 | d_{max} : maximum absolute voltage change during an observation period. |
| d_c (%) | 3.3 | d_c : maximum steady state voltage change during an observation period. |

9.2 Test Instruments

| Description & Manufacturer | Model No. | Serial No. | Cal. Date | Cal. Due |
|---------------------------------------|--------------|-----------------------|---------------|---------------|
| Teseq Harmonics - Flicker Test System | Proflin 2105 | 32A00983 & 1639A01863 | Sep. 16, 2020 | Sep. 15, 2021 |
| Software | CTS 4 | NA | NA | NA |

Note: 1. The calibration interval of the above test instruments is 12 months and the calibrations are traceable to NML/ROC and NIST/USA.
 2. The test was performed in EMS Room No. 1.
 3. Tested Date: Mar. 26, 2021

9.3 Test Arrangement

- The EUT was placed on the top of a wooden table 0.8 meters above the ground and operated to produce the most unfavorable sequence of voltage changes under normal operating conditions.
- During the flick measurement, the measure time shall include that part of whole operation cycle in which the EUT produce the most unfavorable sequence of voltage changes. The observation period for short-term flicker indicator is 10 minutes and the observation period for long-term flicker indicator is 2 hours.

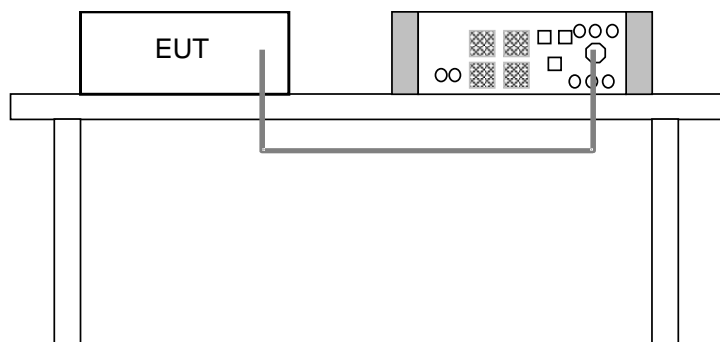

For the actual test configuration, please refer to the related item – Photographs of the Test Configuration.

9.4 Test Results

| | | | |
|----------------------------|--------------------------|-----------------|------------|
| Fundamental Voltage/Ampere | 230.51Vrms/ 0.565Arms | Power Frequency | 50.00Hz |
| Observation (T_p) | 10 min. | Power Factor | 0.902 |
| Environmental Conditions | 20°C, 82% RH | Tested by | Chiming Li |
| Test Mode | Mode 1 | Test Date | 2021/3/26 |

| Test Parameter | Measurement Value | Limit | Remarks |
|----------------|-------------------|-------|---------|
| P_{st} | 0.319 | 1.00 | Pass |
| P_{lt} | 0.139 | 0.65 | Pass |
| T_{max} (ms) | 0 | 500 | Pass |
| d_{max} (%) | 0 | 4 | Pass |
| d_c (%) | 0 | 3.3 | Pass |

- Note: (1) P_{st} means short-term flicker indicator.
 (2) P_{lt} means long-term flicker indicator.
 (3) T_{max} means accumulated time value of $d(t)$ with a deviation exceeding 3.3 %.
 (4) d_{max} means maximum relative voltage change.
 (5) d_c means maximum relative steady-state voltage change.

10 Electrostatic Discharge Immunity Test (ESD)

10.1 Test Specification

| | |
|-----------------------------|--|
| Basic Standard: | EN 61000-4-2 |
| Discharge Impedance: | 330 ohm / 150 pF |
| Discharge Voltage: | Air Discharge: $\pm 2, \pm 4, \pm 8$ kV (Direct) Contact Discharge: $\pm 2, \pm 4, \pm 6$ kV (Indirect & Direct) |
| Number of Discharge: | Minimum 20 times at each test point |
| Discharge Mode: | Single Discharge |
| Discharge Period: | 1-second minimum |

10.2 Test Instruments

| Description & Manufacturer | Model No. | Serial No. | Cal. Date | Cal. Due |
|----------------------------|-----------|------------|--------------|--------------|
| KeyTek, ESD Simulator | MZ-15/EC | 0504259 | Nov. 6, 2020 | Nov. 5, 2021 |

- Note:
1. The calibration interval of the above test instruments is 12 months and the calibrations are traceable to NML/ROC and NIST/USA.
 2. The test was performed in ESD Room No. 1.
 3. Tested Date: Apr. 13, 2021

10.3 Test Arrangement

- a. Electrostatic discharges were applied only to those points and surfaces of the EUT that are accessible to users during normal operation.
- b. The test was performed with at least ten single discharges on the pre-selected points in the most sensitive polarity.
- c. The time interval between two successive single discharges was at least 1 second.
- d. The ESD generator was held perpendicularly to the surface to which the discharge was applied and the return cable was at least 0.2 meters from the EUT.
- e. Contact discharges were applied to the non-insulating coating, with the pointed tip of the generator penetrating the coating and contacting the conducting substrate.
- f. Air discharges were applied with the round discharge tip of the discharge electrode approaching the EUT as fast as possible (without causing mechanical damage) to touch the EUT. After each discharge, the ESD generator was removed from the EUT and re-triggered for a new single discharge. The test was repeated until all discharges were complete.
- g. At least ten single discharges (in the most sensitive polarity) were applied to the **Horizontal Coupling Plane** at points on each side of the EUT. The ESD generator was positioned at a distance of 0.1 meters from the EUT with the discharge electrode touching the **HCP**.
- h. At least ten single discharges (in the most sensitive polarity) were applied to the center of one vertical edge of the **Vertical Coupling Plane** in sufficiently different positions that the four faces of the EUT were completely illuminated. The **VCP** (dimensions 0.5m x 0.5m) was placed vertically to and 0.1 meters from the EUT.

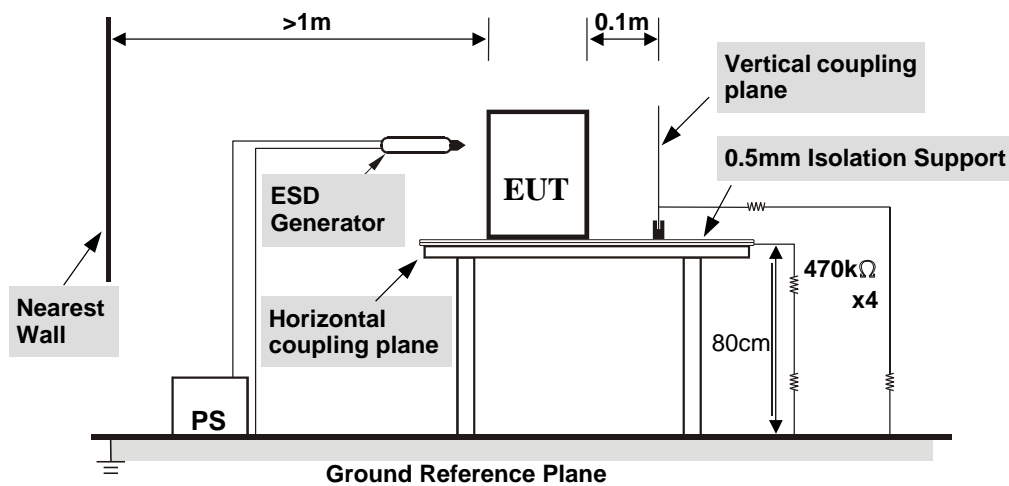

TABLE-TOP EQUIPMENT

The configuration consisted of a wooden table 0.8 meters high standing on the **Ground Reference Plane**. The **GRP** consisted of a sheet of aluminum at least 0.25mm thick, and 2.5 meters square connected to the protective grounding system. A **Horizontal Coupling Plane** (1.6m x 0.8m) was placed on the table and attached to the **GRP** by means of a cable with 940kΩ total impedance. The equipment under test, was installed in a representative system as described in section 7 of EN 61000-4-2, and its cables were placed on the **HCP** and isolated by an insulating support of 0.5mm thickness. A distance of 1-meter minimum was provided between the EUT and the walls of the laboratory and any other metallic structure.

For the actual test configuration, please refer to the related item – Photographs of the Test Configuration.

10.4 Test Results

| | | | |
|--------------------------|----------------------------|-----------|-----------|
| Input Power | 230 Vac, 50 Hz | Tested by | Kent Wang |
| Environmental conditions | 22 °C, 48% RH 1007 mbar | Test Date | 2021/4/13 |
| Test mode | Mode 1 | | |

Test Results of Direct Application

| Discharge Level (kV) | Polarity (+/-) | Test Point | Contact Discharge | Air Discharge | Performance Criterion |
|----------------------|----------------|------------|-------------------|---------------|-----------------------|
| 2, 4 | +/- | 1-6 | Note 1 | NA | A |
| 6 | +/- | 1, 2 | Note 1 | NA | A |
| 6 | +/- | 3-5 | Note 2 | NA | B |
| 6 | +/- | 6 | Note 2, 3 | NA | B |
| 2, 4, 8 | +/- | 9, 11-16 | NA | Note 1 | A |
| 2, 4 | +/- | 7, 8, 10 | NA | Note 1 | A |
| 8 | +/- | 7, 8 | NA | Note 2 | B |
| 8 | +/- | 10 | NA | Note 2, 3 | B |

Description of test points of direct application: Please refer to following page for representative mark only.

Test Results of Indirect Application

| Discharge Level (kV) | Polarity (+/-) | Test Point | Horizontal Coupling Plane | Vertical Coupling Plane | Performance Criterion |
|----------------------|----------------|------------|---------------------------|-------------------------|-----------------------|
| 2, 4 | +/- | Four Sides | Note 1 | Note 1 | A |
| 6 | +/- | Four Sides | Note 2 | Note 1 | B |

Description of test points of indirect application:

1. Front side 2. Rear side 3. Right side 4. Left side

- Note: 1. The EUT function was correct during the test.
 2. The image on the screen disappeared during the test, but self-recoverable after the test.
 3. PoE camera ping time out during the test, but self-recoverable after the test.

Description of Test Points

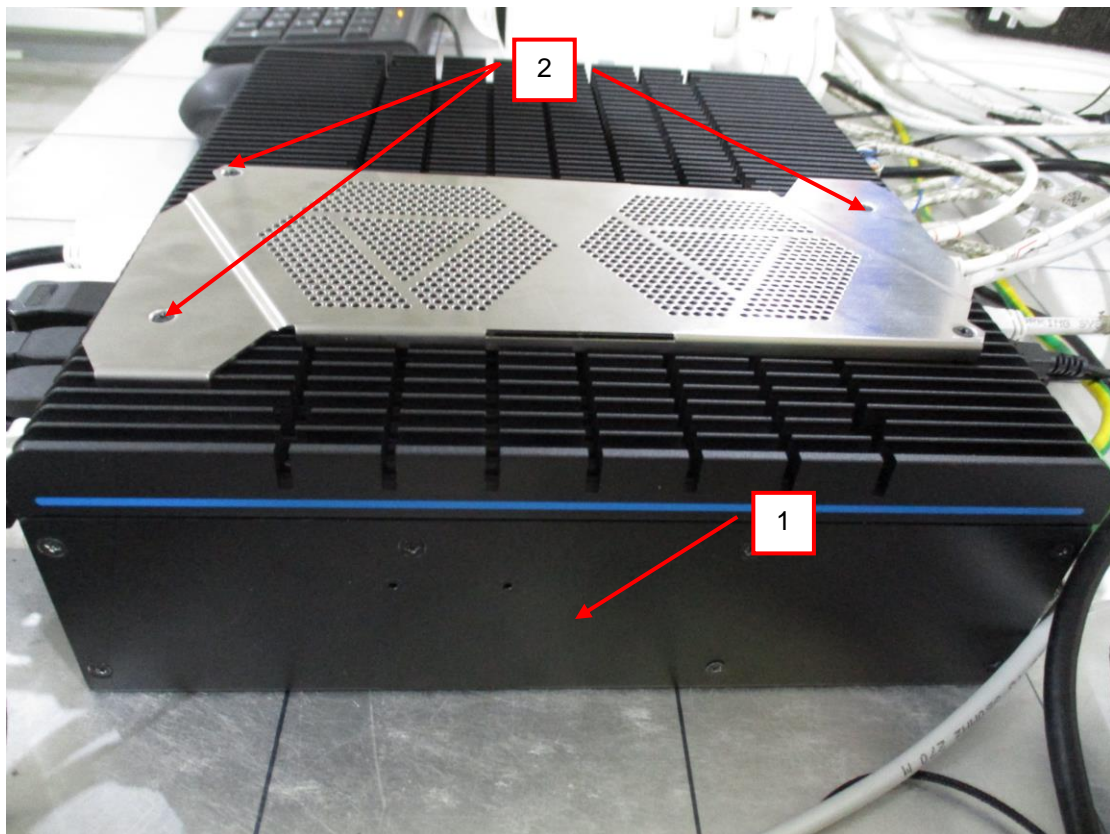
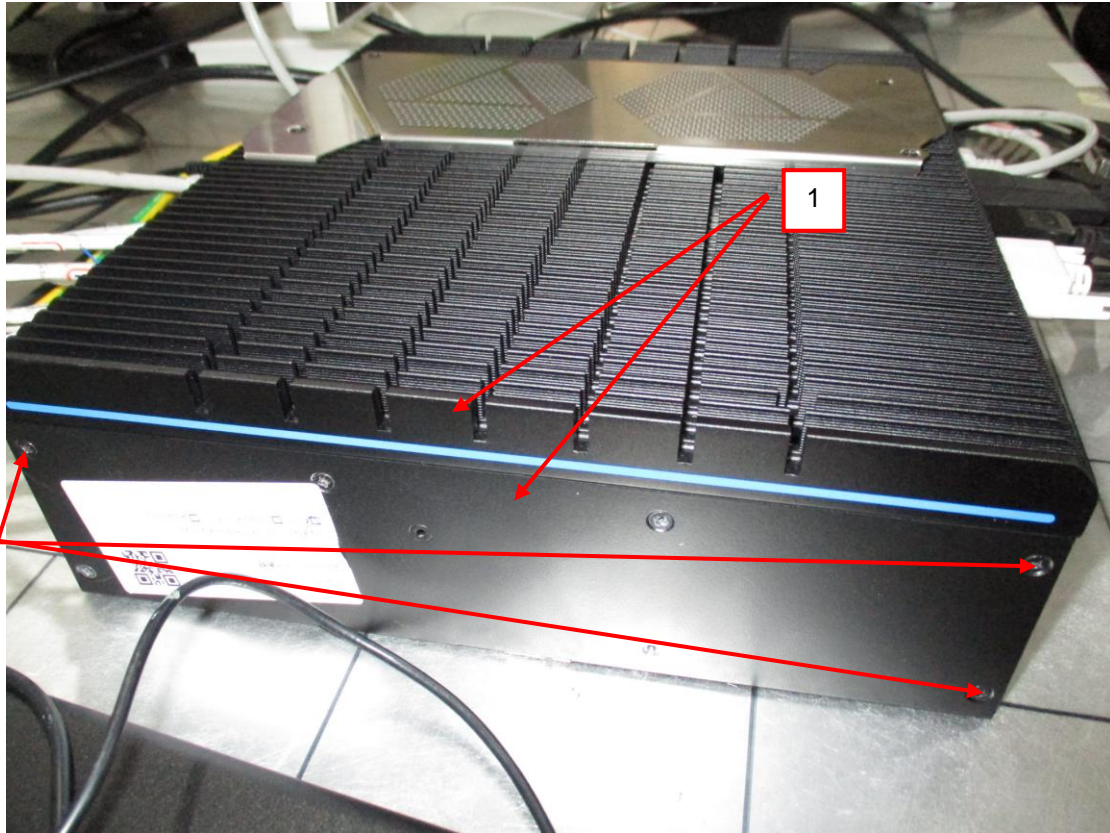

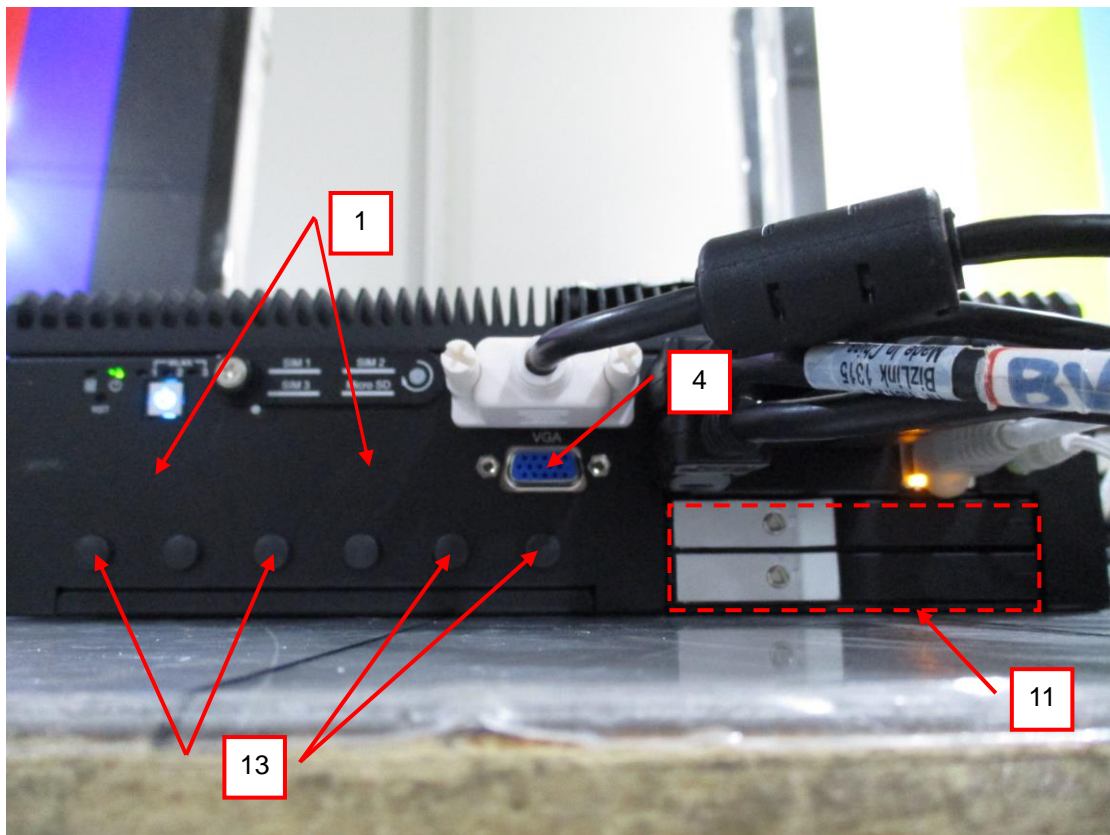
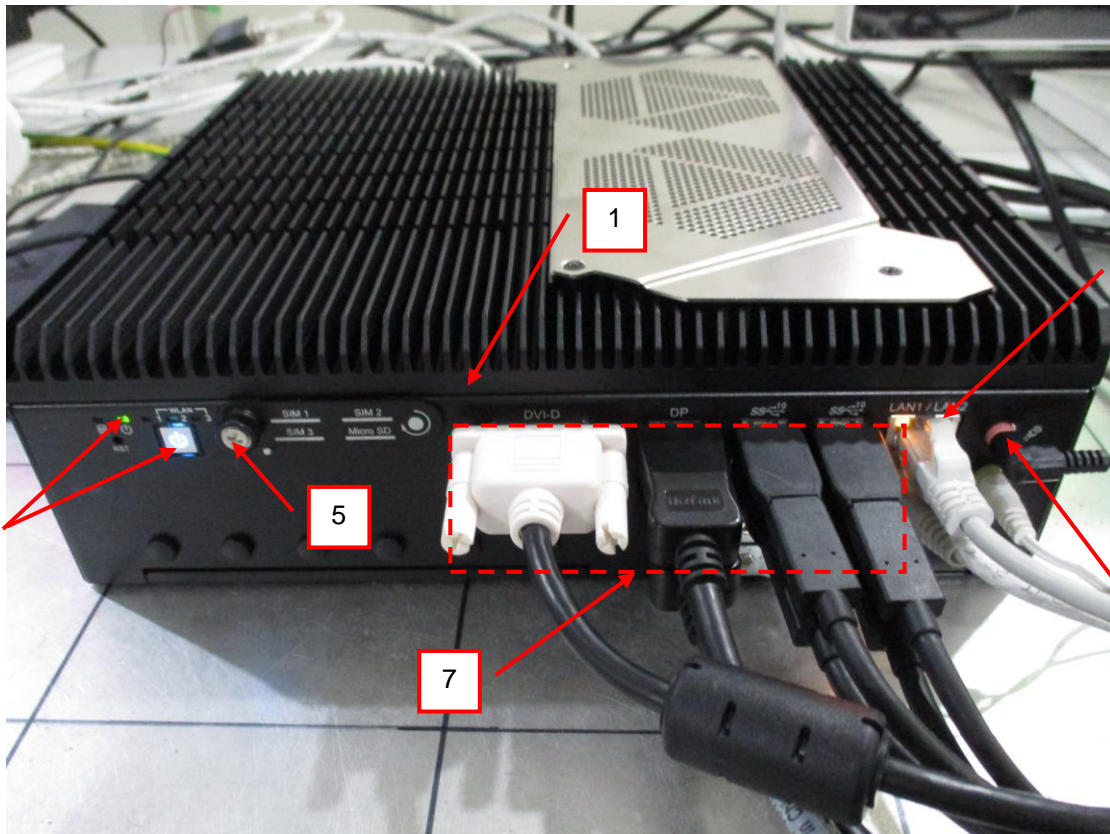

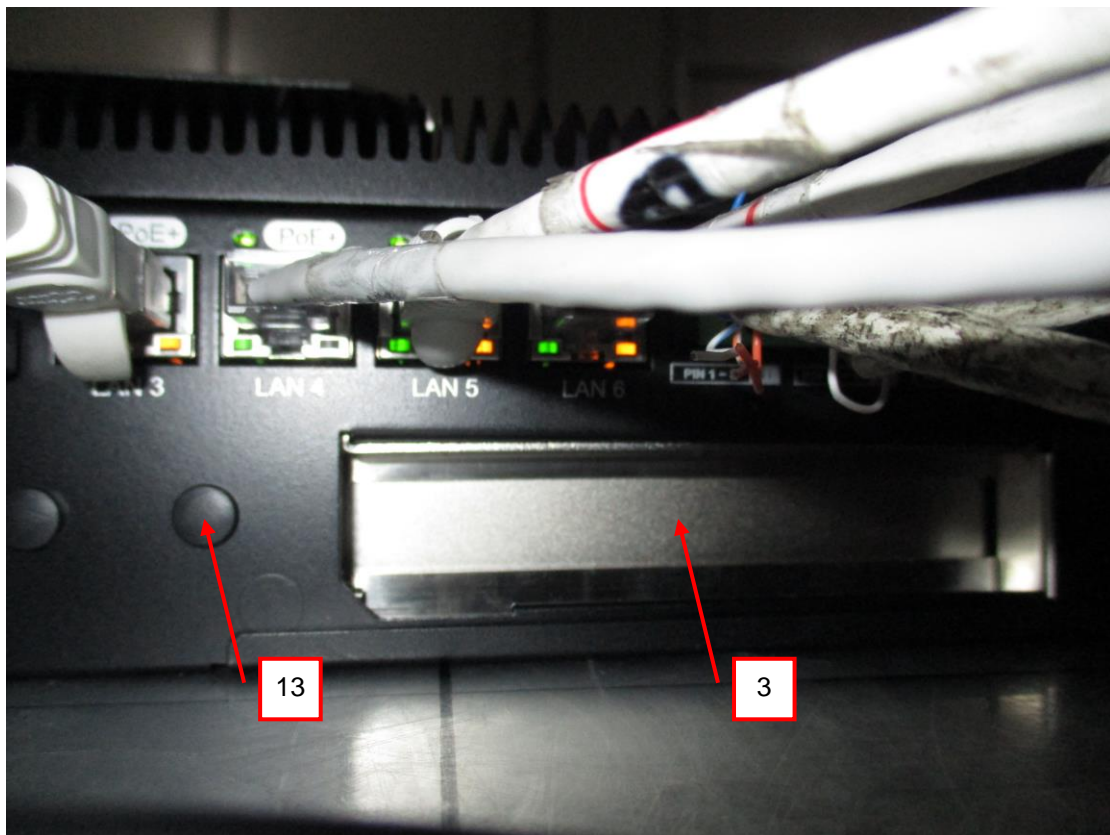
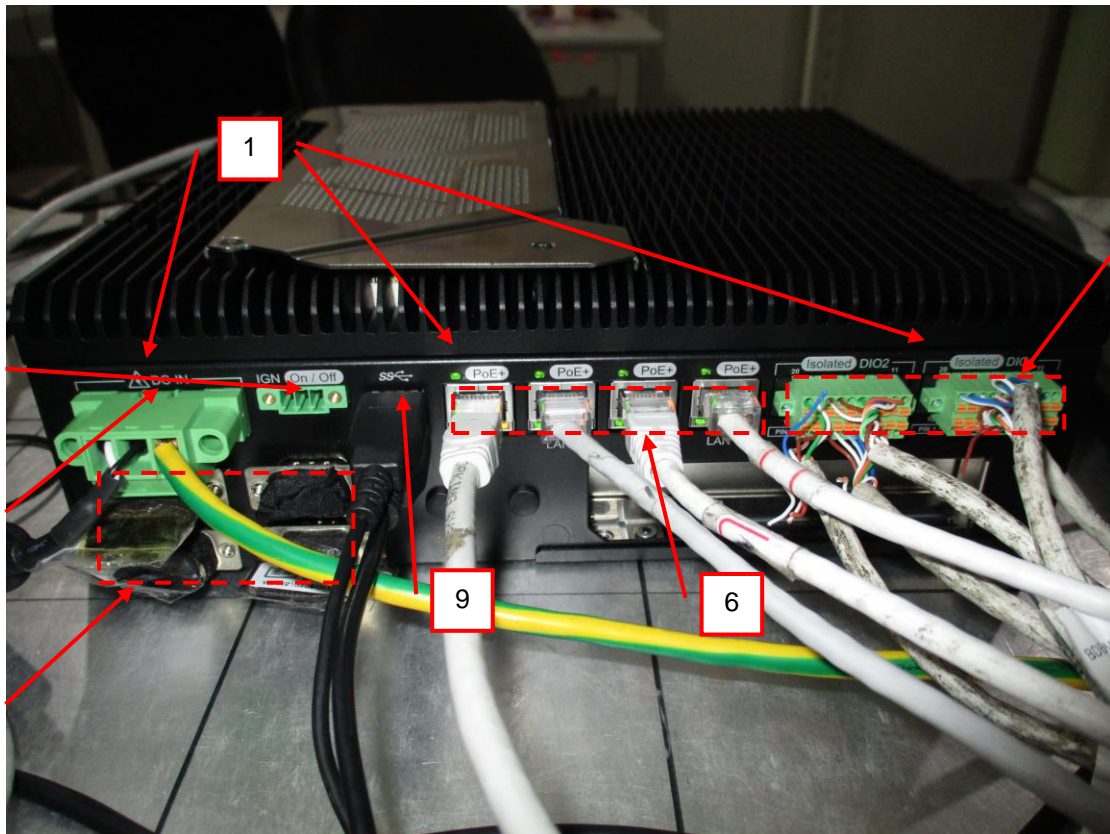



11 Radio-frequency Electromagnetic Field Immunity Test (RS)

11.1 Test Specification

| | |
|----------------------------------|------------------------------------|
| Basic Standard: | EN 61000-4-3 |
| Frequency Range, Field Strength: | 80-800 MHz, 20V/m ¹ |
| | 800-1000 MHz, 20V/m |
| | 1400-2000 MHz, 10V/m |
| | 2000-2700 MHz, 5V/m |
| Modulation: | 5100-6000 MHz, 3V/m |
| | 1kHz Sine Wave, 80%, AM Modulation |
| Frequency Step: | 1 % of preceding frequency value |
| Polarity of Antenna: | Horizontal and Vertical |
| Antenna Height: | 1.5m |
| Dwell Time: | 3 seconds |

Note 1: This limit applies to equipment mounted in the passenger compartments, drivers cab or external to the rolling stock (roof, underframe). For equipment mounted in all other areas a severity level of 10 V/m may be used.

11.2 Test Instruments

| Description & Manufacturer | Model No. | Serial No. | Cal. Date | Cal. Due |
|--|--------------|------------|--------------|--------------|
| AgilentSignal Generator | E8257D | MY48050465 | Jun. 8, 2020 | Jun. 7, 2021 |
| BONN RF Amplifier | BSA 0125-800 | 1912556 | NA | NA |
| TESTQAmplifier | CBA 1G-275 | T44344 | NA | NA |
| AR RF Amplifier | 35S4G8AM4 | 0326094 | NA | NA |
| AR RF Amplifier | 100S1G4M3 | 0329249 | NA | NA |
| AR Controller | SC1000M3 | 305910 | NA | NA |
| ARLog-Periodic Antenna | AT6080 | 0329465 | NA | NA |
| BOONTON RF Voltage Meter | 4232A | 10180 | May 29, 2020 | May 28, 2021 |
| BOONTON Power Sensor | 51011-EMC | 34152 | May 29, 2020 | May 28, 2021 |
| BOONTON Power Sensor | 51011-EMC | 34153 | May 29, 2020 | May 28, 2021 |
| EMCO BiconiLog Antenna | 3141 | 1001 | NA | NA |
| ARHigh Gain Antenna | AT4010 | 0329800 | NA | NA |
| SchwarzbeckLOG ANTENNA | Stlp 9149 | 9149-260 | NA | NA |
| CHANCE MOST Full Anechoic Chamber (9x5x3m) | Chance Most | RS-002 | Feb. 4, 2021 | Feb. 3, 2022 |
| Software | RS_V7.6 | NA | NA | NA |

- Note:
1. The calibration interval of the above test instruments is 12 months and the calibrations are traceable to NML/ROC and NIST/USA.
 2. The test was performed in RS Room No.2.
 3. The transmit antenna was located at a distance of 3 meters from the EUT.
 4. Tested Date: Mar. 30, 2021

11.3 Test Arrangement

The test procedure was in accordance with EN 61000-4-3.

- a. The testing was performed in a fully anechoic chamber.
- b. The frequency ranges and field strength levels are 80-800 MHz, 20V/m, 800-1000 MHz, 20V/m, 1400-2000 MHz, 10V/m, 2000-2700 MHz, 5V/m and 5100-6000 MHz, 3V/m with the signal 80% amplitude modulated with a 1kHz sine wave.
- c. The test was performed with the EUT exposed to both vertically and horizontally polarized fields on each of the four sides.

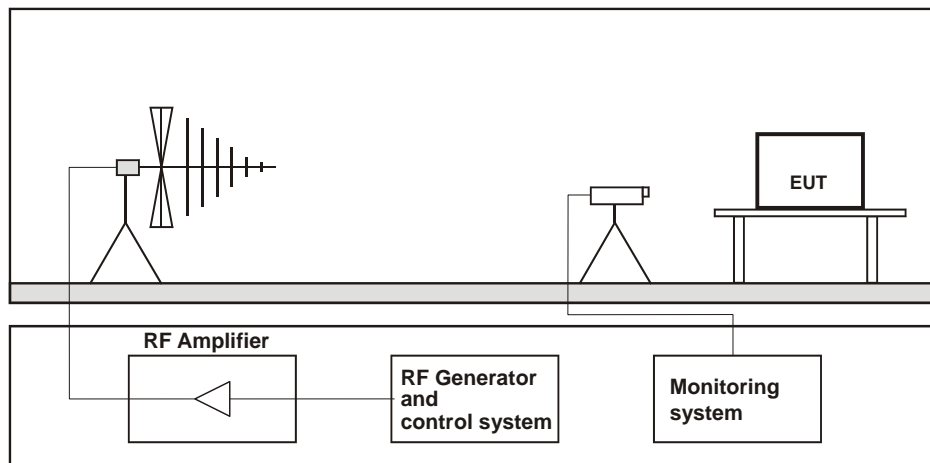

Table-top Equipment

The EUT installed in a representative system as described in section 7 of EN 61000-4-3 was placed on a non-conductive table 0.8 meters in height. The system under test was connected to the power and signal wire according to relevant installation instructions.

For the actual test configuration, please refer to the related item – Photographs of the Test Configuration.

11.4 Test Results

| | | | |
|--------------------------|----------------|-----------|-----------|
| Input Power | 230 Vac, 50 Hz | Tested by | Sean Chou |
| Environmental conditions | 22 °C, 70% RH | Test Date | 2021/3/30 |
| Test mode | Mode 1 | | |

| Frequency (MHz) | Polarity | Azimuth(°) | Applied Field Strength | | Observation | Test Distance (m) | Performance Criterion |
|-----------------|----------|-----------------|------------------------|---------------|-------------|-------------------|-----------------------|
| | | | (V/m) | Modulation | | | |
| 80 - 800 | V&H | 0, 90, 180, 270 | 20 | 80% AM (1kHz) | Note | 1.5 | A |
| 800 - 1000 | V&H | 0, 90, 180, 270 | 20 | 80% AM (1kHz) | Note | 1.5 | A |
| 1400 - 2000 | V&H | 0, 90, 180, 270 | 10 | 80% AM (1kHz) | Note | 3 | A |
| 2000 - 2700 | V&H | 0, 90, 180, 270 | 5 | 80% AM (1kHz) | Note | 3 | A |
| 5100 - 6000 | V&H | 0, 90, 180, 270 | 3 | 80% AM (1kHz) | Note | 3 | A |

Note: The EUT function was correct during the test.

12 Electrical Fast Transient/Burst Immunity Test (EFT)

12.1 Test Specification

| | |
|-------------------------------|---|
| Basic Standard: | EN 61000-4-4 |
| Test Voltage: | Signal & communication, process measurement & control ports: $\pm 2\text{kV}$, Capacitive clamp Battery referenced ports (except at the output of energy sources), Auxiliary a.c. power input ports (rated voltage $\leq 400\text{ Vrms}$): $\pm 2\text{kV}$ |
| Impulse Repetition Frequency: | 5kHz |
| Impulse Wave Shape: | 5/50 (T_r/T_h) ns |
| Burst Duration: | 15 ms |
| Burst Period: | 300 ms |
| Test Duration: | 1 min. |

12.2 Test Instruments

| Description & Manufacturer | Model No. | Serial No. | Cal. Date | Cal. Due |
|----------------------------|-----------|------------|---------------|---------------|
| Haefely, EFT Generator | PEFT 4010 | 154954 | Apr. 20, 2020 | Apr. 19, 2021 |
| Haefely, Capacitive Clamp | IP4A | 155173 | Apr. 20, 2020 | Apr. 19, 2021 |

- Note:
1. The calibration interval of the above test instruments is 12 months and the calibrations are traceable to NML/ROC and NIST/USA.
 2. The test was performed in EFT Room.
 3. Tested Date: Mar. 17, 2021

12.3 Test Arrangement

- Both positive and negative polarity discharges were applied.
- The distance between any coupling devices and the EUT should be 0.5 m for table-top equipment testing, and 1.0 m for floor standing equipment.
- The duration time of each test sequential was 1 minute.
- The transient/burst waveform was in accordance with EN 61000-4-4, 5/50 ns.

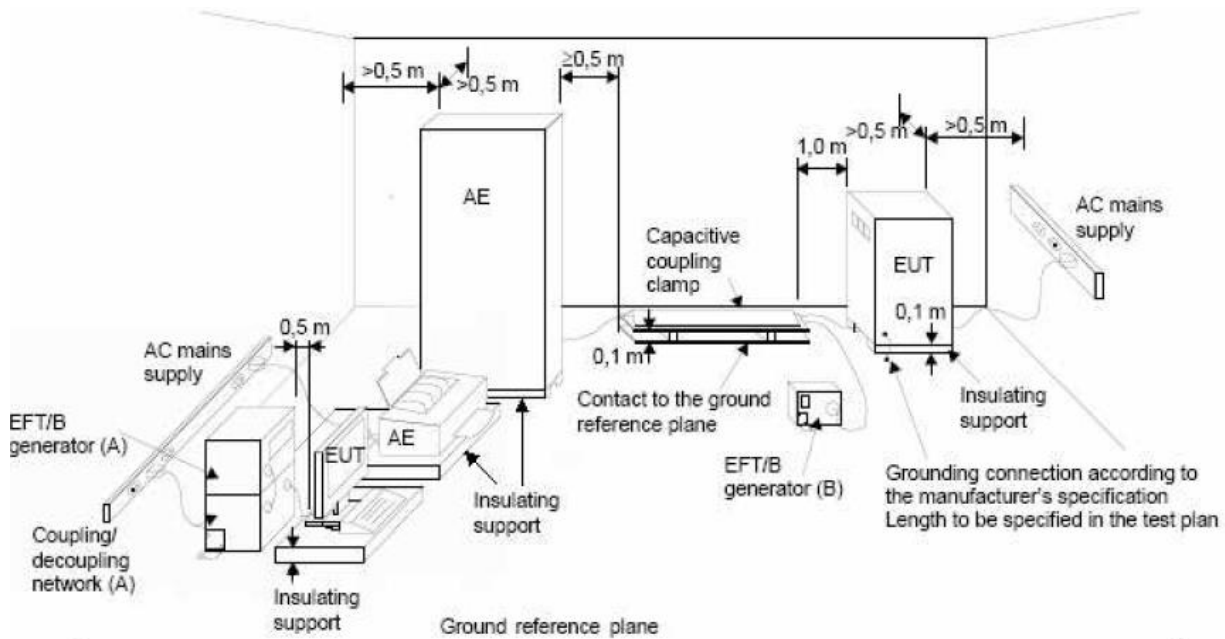

NOTE:

- location for supply line coupling
- location for signal lines coupling

For the actual test configuration, please refer to the related item – Photographs of the Test Configuration.

12.4 Test Results

| | | | |
|--------------------------|----------------|-----------|--------------|
| Input Power | 230 Vac, 50 Hz | Tested by | Thomas Cheng |
| Environmental conditions | 23 °C, 69% RH | Test Date | 2021/3/17 |
| Test mode | Mode 1 | | |

Battery referenced ports (except at the output of energy sources),
 Auxiliary a.c. power input ports (rated voltage \leq 400 Vrms)

| Voltage (kV) | Test Point | Polarity (+/-) | Observation | Performance Criterion |
|--------------|------------|----------------|-------------|-----------------------|
| 2 | L1 | +/- | Note | A |
| 2 | L2 | +/- | Note | A |
| 2 | PE | +/- | Note | A |
| 2 | L1-L2- PE | +/- | Note | A |

Signal & communication, process measurement & control ports

| Voltage (kV) | Test Point | Polarity (+/-) | Observation | Performance Criterion |
|--------------|------------|----------------|-------------|-----------------------|
| 2 | LAN 1 | +/- | Note | A |
| 2 | PoE LAN 3 | +/- | Note | A |

Note: The EUT function was correct during the test.

13 Surge Immunity Test

13.1 Test Specification

| | |
|--------------------------|--|
| Basic Standard: | EN 61000-4-5 |
| Wave-Shape: | Battery referenced ports (except at the output of energy sources), Auxiliary a.c. power input ports (rated voltage ≤ 400 Vrms): 1.2/50 μ s Open Circuit Voltage 8/20 μ s Short Circuit Current |
| Test Voltage: | Line to line: ± 0.5 kV, ± 1 kV, Line to ground: ± 0.5 kV, ± 1 kV, ± 2 kV output impedance of 42 Ω (40 Ω and 2 Ω generator) and a coupling capacitance of 0,5 μ F |
| AC Phase Angle (degree): | 0°, 90°, 180°, 270° |
| Pulse Repetition Rate: | 1 time / 20 sec. |
| Number of Tests: | 5 positive and 5 negative at selected points |

13.2 Test Instruments

| Description & Manufacturer | Model No. | Serial No. | Cal. Date | Cal. Due |
|---|-----------------|------------|---------------|---------------|
| TESEQ, Surge Simulator | NSG 3060 | 1572 | May 12, 2020 | May 11, 2021 |
| TESEQ, CDN | CDN 3083-100 | 1215 | May 12, 2020 | May 11, 2021 |
| Coupling Decoupling Network | CDN-UTP8 | 045 | Aug. 18, 2020 | Aug. 17, 2021 |
| TESEQ Coupling Decoupling Network | CDN HSS-2 | 41009 | May 12, 2020 | May 11, 2021 |
| TESEQ Coupling Decoupling Network | CDN 118-T8 | 40386 | Sep. 8, 2020 | Sep. 7, 2021 |
| TESEQ CDN for Unshielded Unsymmetrical Signal & Data Lines | CDN117 | 40144 | Sep. 8, 2020 | Sep. 7, 2021 |

- Note:
1. The calibration interval of the above test instruments is 12 months and the calibrations are traceable to NML/ROC and NIST/USA.
 2. The test was performed in EMS Room No. 2.
 3. Tested Date: Mar. 29, 2021

13.3 Test Arrangement

The surge is to be applied to the EUT power supply terminals via the capacitive coupling network. Decoupling networks are required in order to avoid possible adverse effects on equipment not under test that may be powered by the same lines, and to provide sufficient decoupling impedance to the surge wave. The power cord between the EUT and the coupling/decoupling networks shall be 2 meters in length (or shorter).

For double-insulated products without PE or external earth connections, the test shall be done in a similar way as for grounded products but without adding any additional external grounded connections. If there are no other possible connections to earth, line-to-ground tests may be omitted.

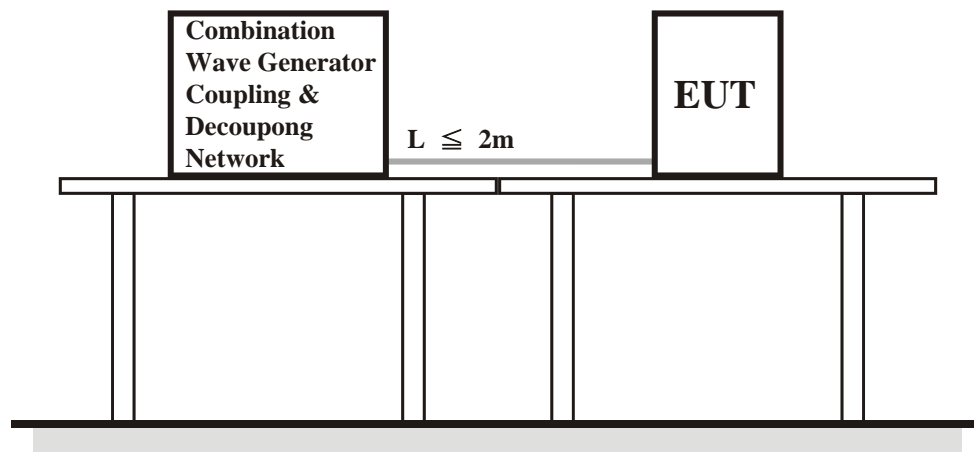

For the actual test configuration, please refer to the related item – Photographs of the Test Configuration.

13.4 Test Results

| | | | |
|--------------------------|----------------|-----------|------------|
| Input Power | 230 Vac, 50 Hz | Tested by | Chiming Li |
| Environmental conditions | 22 °C, 70% RH | Test Date | 2021/3/29 |
| Test mode | Mode 1 | | |

Battery referenced ports (except at the output of energy sources),
 Auxiliary a.c. power input ports (rated voltage ≤ 400 Vrms)

| Voltage (kV) | Test Point | Polarity (+/-) | Observation | Performance Criterion |
|--------------|------------|----------------|-------------|-----------------------|
| 0.5, 1 | L1-L2 | +/- | Note | A |
| 0.5, 1, 2 | L1-PE | +/- | Note | A |
| 0.5, 1, 2 | L2-PE | +/- | Note | A |

Note: The EUT function was correct during the test.

14 Immunity to Conducted Disturbances Induced by RF Fields (CS)

14.1 Test Specification

| | |
|------------------|--|
| Basic Standard: | EN 61000-4-6 |
| Frequency Range: | 0.15 MHz - 80 MHz |
| Voltage Level: | Battery referenced ports (except at the output of energy sources), Auxiliary a.c. power input ports (rated voltage \leq 400 Vrms), Signal & communication, process measurement & control ports: 10 V |
| Modulation: | 1kHz Sine Wave, 80%, AM Modulation |
| Frequency Step: | 1 % of preceding frequency value |
| Dwell Time | 3 seconds |

14.2 Test Instruments

| Description & Manufacturer | Model No. | Serial No. | Cal. Date | Cal. Due |
|---|----------------|------------|---------------|---------------|
| ROHDE & SCHWARZ Signal Generator | SML03 | 101801 | Jan. 13, 2021 | Jan. 12, 2022 |
| Digital Sweep Function Generator | 8120 | 984801 | NA | NA |
| AR Power Amplifier | 75A250AM1 | 306331 | NA | NA |
| FCC Coupling Decoupling Network | FCC-801-M2-16A | 01047 | Jun. 18, 2020 | Jun. 17, 2021 |
| FISCHER CUSTOM COMMUNICATIONS EM Injection Clamp | F-203I-23mm | 455 | NA | NA |
| FISCHER CUSTOM COMMUNICATIONS Current Injection Clamp | F-120-9A | 361 | Jul. 30, 2020 | Jul. 29, 2021 |
| B&K Ear Simulator | 4185 | 2553594 | NA | NA |
| EM TEST Coupling Decoupling Network | CDN M1/32A | 306508 | Jun. 18, 2020 | Jun. 17, 2021 |
| TESEQ Coupling Decoupling Network | CDN T800 | 34428 | Jun. 18, 2020 | Jun. 17, 2021 |
| TESEQ Coupling Decoupling Network | CDN T800 | 29459 | Jun. 18, 2020 | Jun. 17, 2021 |
| TESEQ Coupling Decoupling Network | CDN T8-230 | 56641 | Feb. 25, 2021 | Feb. 24, 2022 |
| TESEQ Coupling Decoupling Network | CDN T8-230 | 56642 | Feb. 25, 2021 | Feb. 24, 2022 |
| R&S Power Sensor | NRV-Z5 | 837878/039 | Nov. 10, 2020 | Nov. 9, 2021 |
| R&S Power Meter | NRVD | 837794/040 | Nov. 10, 2020 | Nov. 9, 2021 |
| TESEQ Coupling Decoupling Network | CDN M232 | 37702 | Jun. 18, 2020 | Jun. 17, 2021 |
| TESEQ Coupling Decoupling Network | CDN M332 | 41258 | Jun. 18, 2020 | Jun. 17, 2021 |
| TESEQ Coupling Decoupling Network | CDN M332 | 41256 | Jun. 18, 2020 | Jun. 17, 2021 |
| TESEQ Coupling Decoupling Network | CDN T8-10 | 40376 | Jun. 18, 2020 | Jun. 17, 2021 |
| TESEQ Coupling Decoupling Network | CDN T8-230 | 56643 | Feb. 25, 2021 | Feb. 24, 2022 |
| TESEQ Coupling Decoupling Network | CDN S200 | 53490 | May 27, 2020 | May 26, 2021 |
| TESEQ Coupling Decoupling Network | CDN S400 | 52115 | Jun. 18, 2020 | Jun. 17, 2021 |
| TESEQ Coupling Decoupling Network | CDN T400A | 49918 | Feb. 25, 2021 | Feb. 24, 2022 |
| FCC Coupling Decoupling Network | FCC-801-M5-50A | 100018 | Jan. 19, 2021 | Jan. 18, 2022 |
| TESEQ Coupling Decoupling Network | CDN T2A-10 | 54942 | Feb. 25, 2021 | Feb. 24, 2022 |
| TESEQ Coupling Decoupling Network | CDN S751A | 56435 | Feb. 25, 2021 | Feb. 24, 2022 |
| TESEQ Coupling Decoupling Network | CDN ST08A | 56527 | Feb. 25, 2021 | Feb. 24, 2022 |
| TESEQ Coupling Decoupling Network | CDN ST08A | 56525 | Feb. 25, 2021 | Feb. 24, 2022 |
| TESEQ Coupling Decoupling Network | CDN M432S | 56519 | Feb. 25, 2021 | Feb. 24, 2022 |
| TESEQ Coupling Decoupling Network | CDN S751A | 56436 | Feb. 25, 2021 | Feb. 24, 2022 |
| Software | CS_V7.4.2 | NA | NA | NA |

- Note:
1. The calibration interval of the above test instruments is 12 months and the calibrations are traceable to NML/ROC and NIST/USA.
 2. The test was performed in CS Room No. 1.
 3. Tested Date: Mar. 26, 2021

14.3 Test Arrangement

- The EUT shall be tested within its intended operating and climatic conditions.
- An artificial hand was placed on the hand-held accessory and connected to the ground reference plane.
- One of the CDNs not used for injection was terminated with 50 ohm, providing only one return path. All other CDNs were coupled as decoupling networks.
- The frequency range is swept from 150 kHz to 80 MHz, using the signal level established during the setting process and with a disturbance signal of 80 % amplitude. The signal is modulated with a 1 kHz sine wave, pausing to adjust the RF signal level or the switch coupling devices as necessary. Where the frequency is swept incrementally, the step size shall not exceed 1 % of the preceding frequency value.
- Attempts should be made to fully exercise the EUT during testing, and to fully interrogate all exercise modes selected for susceptibility.

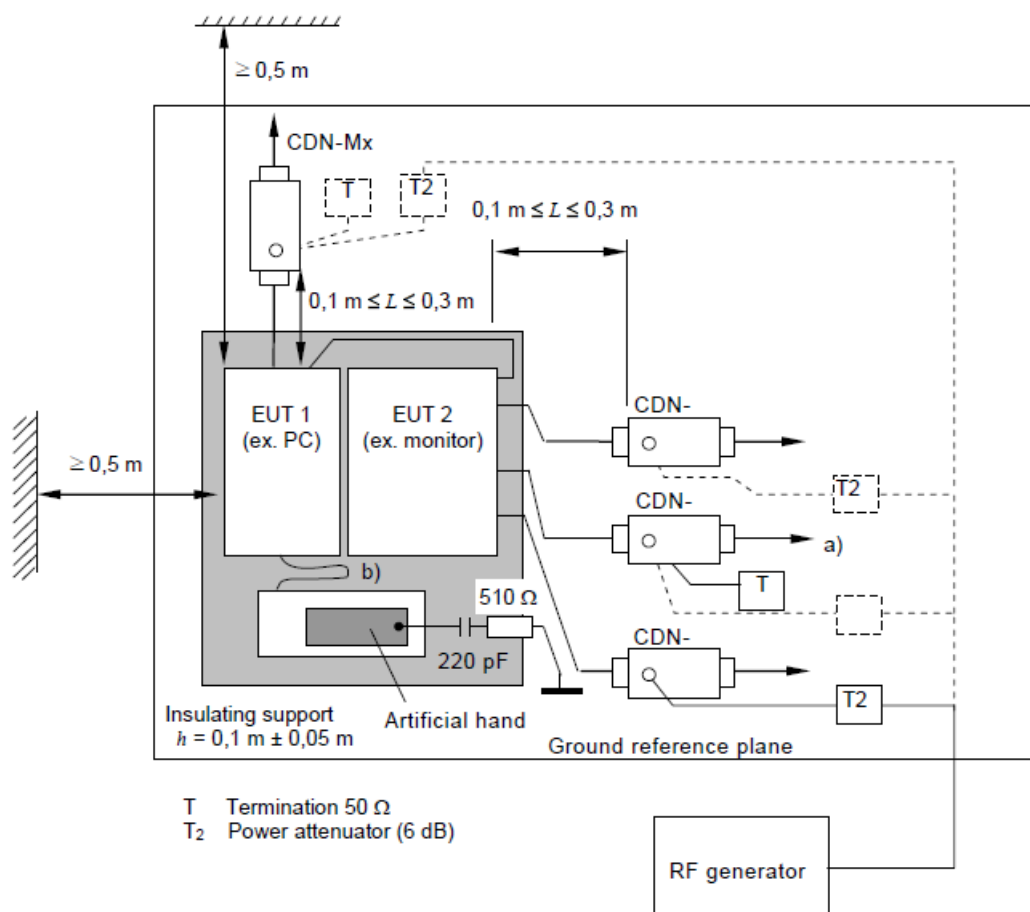

IEC 2606/13

- Note:**
- The EUT clearance from any metallic obstacles shall be at least 0,5 m.
 - Interconnecting cables (≤ 1 m) belonging to the EUT shall remain on the insulating support.
 - The equipment to be tested is placed on an insulating support of 0.1 meters height above a ground reference plane. All relevant cables shall be provided with the appropriate coupling and decoupling devices at a distance between 0.1 meters and 0.3 meters from the projected geometry of the EUT on the ground reference plane.

For the actual test configuration, please refer to the related item – Photographs of the Test Configuration.

14.4 Test Results

| | | | |
|--------------------------|----------------|-----------|------------|
| Input Power | 230 Vac, 50 Hz | Tested by | Chiming Li |
| Environmental conditions | 23 °C, 72% RH | Test Date | 2021/3/26 |
| Test mode | Mode 1 | | |

| Frequency (MHz) | Level (V rms) | Tested Line | Injection Method | Return Path | Observation | Remark | Performance Criterion |
|-----------------|---------------|-------------|------------------|-------------|-------------|--------|-----------------------|
| 0.15 – 80 | 10 | AC Power | CDN-M3 | CDN-M1 | Note | - | A |
| 0.15 – 80 | 10 | LAN 1 | CDN-T8 | CDN-M1 | Note | - | A |
| 0.15 – 80 | 10 | PoE LAN 3 | CDN-T8 | CDN-M1 | Note | - | A |

Note: The EUT function was correct during the test.

15 Pictures of Test Arrangements

15.1 Conducted Disturbance at Auxiliary a.c. or d.c. power ports



15.2 Radiated Disturbance up to 1 GHz



15.3 Radiated Disturbance above 1 GHz

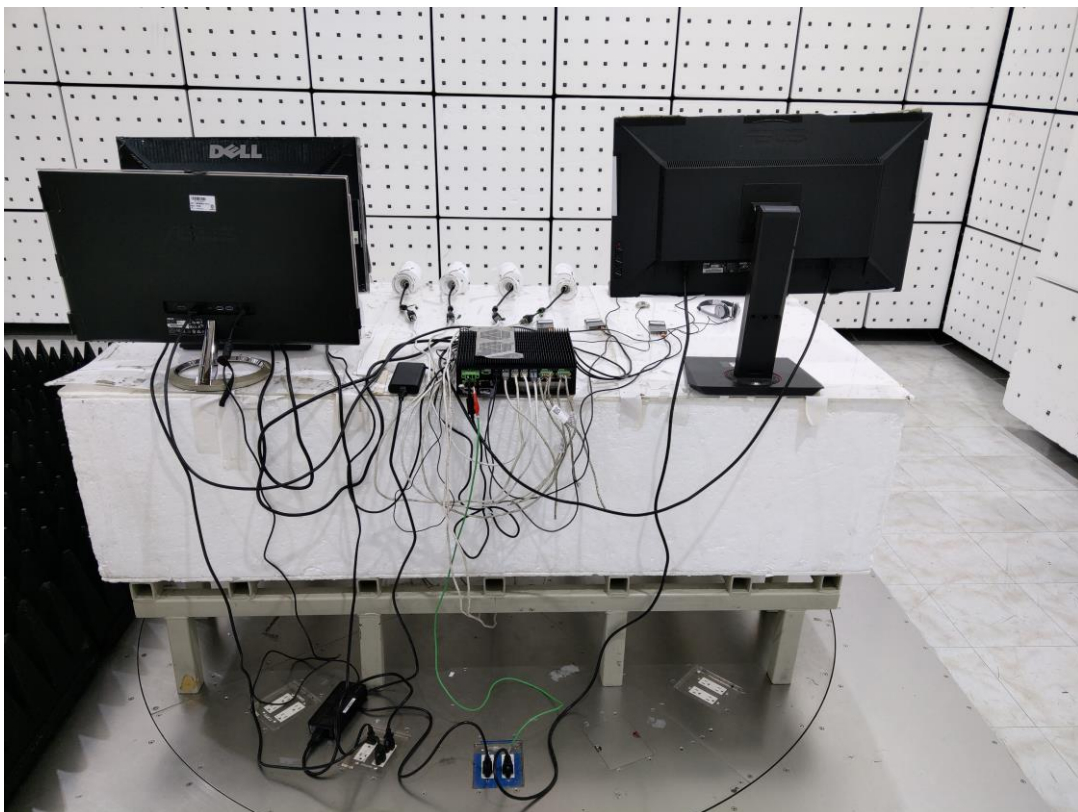

15.4 Harmonics Current, Voltage Fluctuations and Flicker Measurement



15.5 Electrostatic Discharge Immunity Test (ESD)

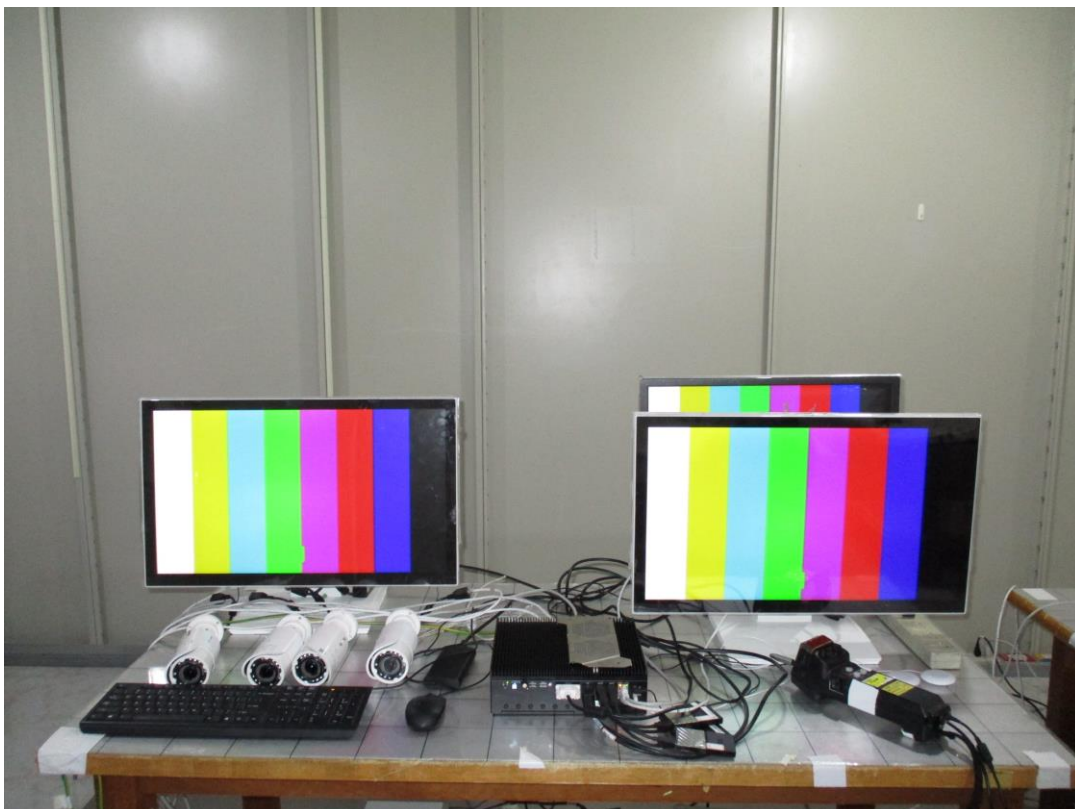

15.6 Radio-frequency Electromagnetic Field Immunity Test (RS)

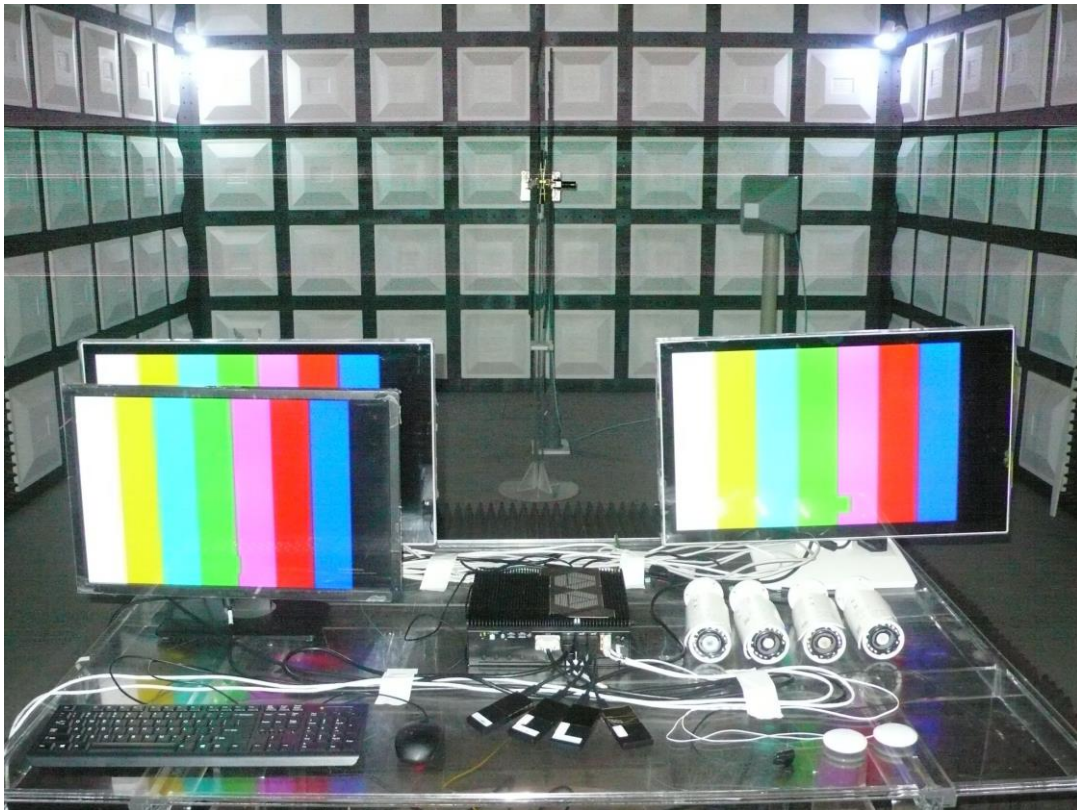

15.7 Fast Transients (EFT)

Mains port

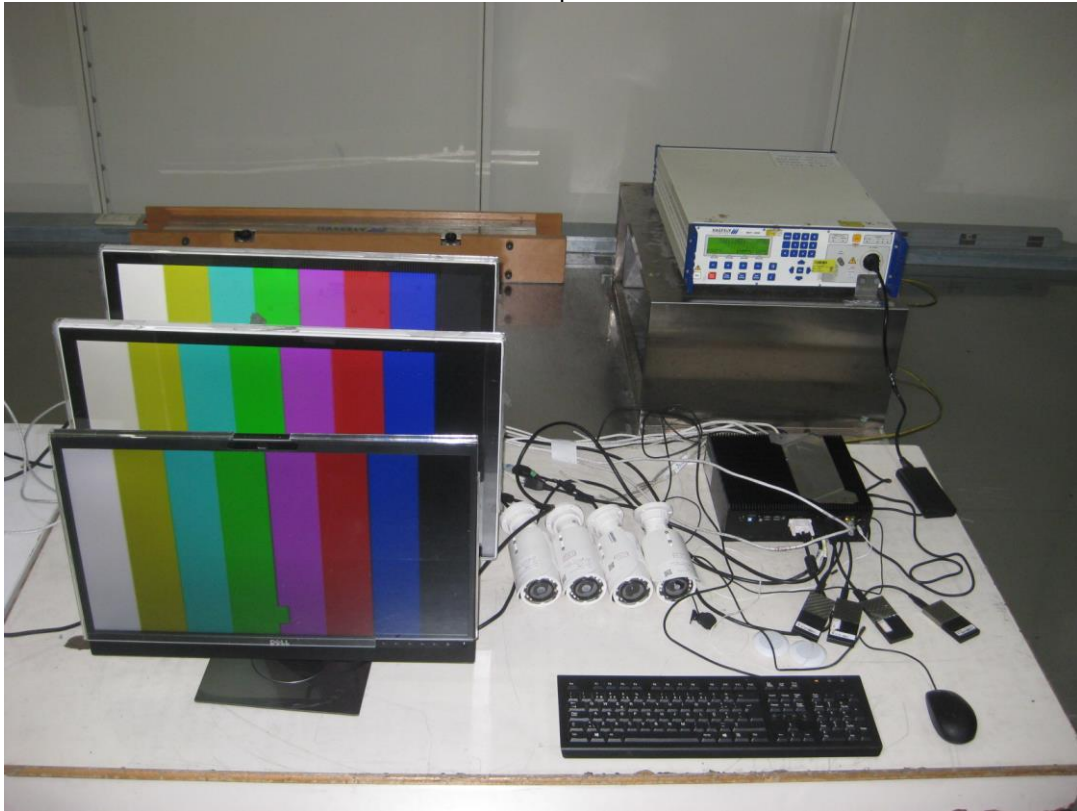

LAN



PoE LAN



15.8 Surge

Mains ports



15.9 Radio-frequency common mode (CS)

Mains port

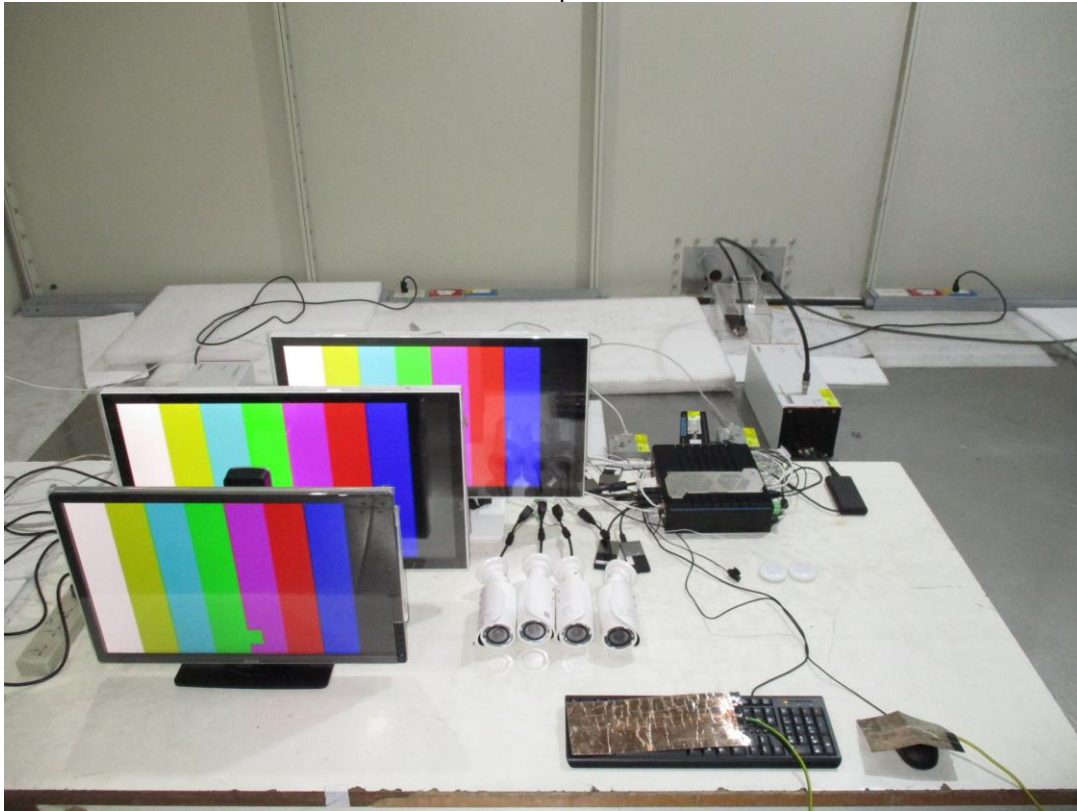

LAN

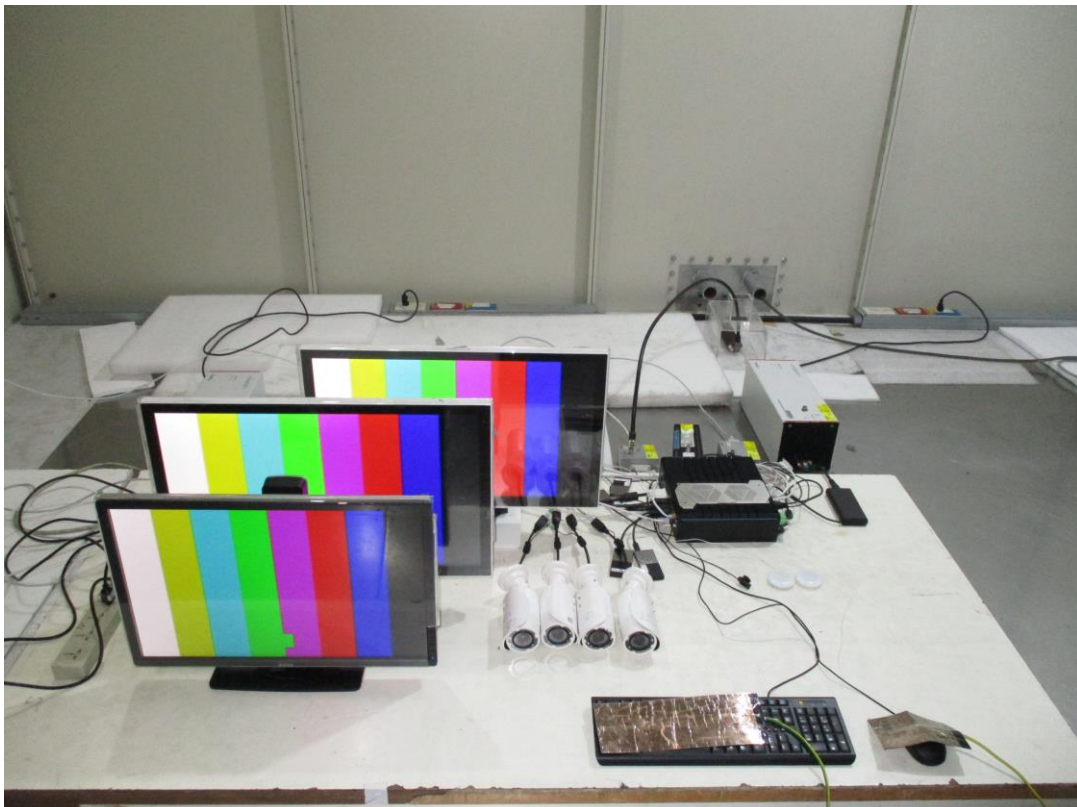

PoE LAN

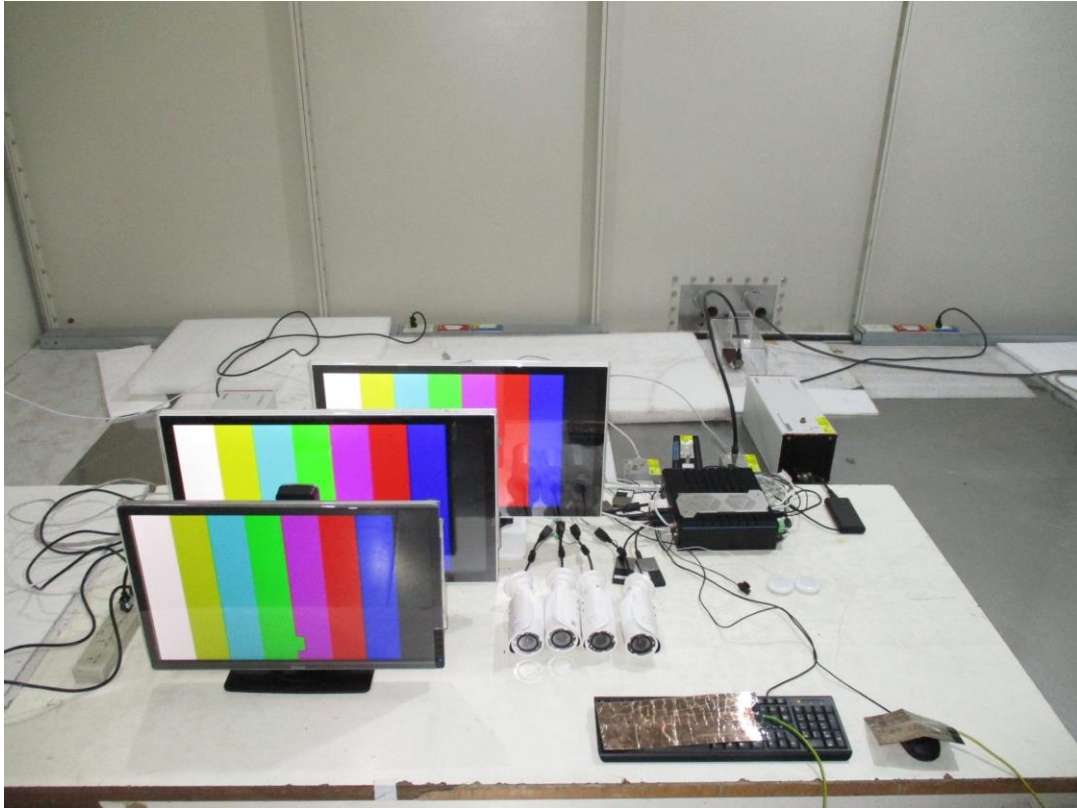

Appendix – Information of the Testing Laboratories

We, Bureau Veritas Consumer Products Services (H.K.) Ltd., Taoyuan Branch, were founded in 1988 to provide our best service in EMC, Radio, Telecom and Safety consultation. Our laboratories are accredited and approved according to ISO/IEC 17025.

If you have any comments, please feel free to contact us at the following:

Lin Kou EMC/RF Lab

Tel: 886-2-26052180

Fax: 886-2-26051924

Hsin Chu EMC/RF/Telecom Lab

Tel: 886-3-6668565

Fax: 886-3-6668323

Hwa Ya EMC/RF/Safety Lab

Tel: 886-3-3183232

Fax: 886-3-3270892

Email: service.adt@tw.bureauveritas.com

Web Site: www.bureauveritas-adt.com

The address and road map of all our labs can be found in our web site also.

--- END ---